

Original operating instructions

AMS 355i

Optical laser measurement system – DeviceNet



© 2023

Leuze electronic GmbH + Co. KG

In der Braike 1

D-73277 Owen / Germany

Phone: +49 7021 573-0

Fax: +49 7021 573-199

<http://www.leuze.com>

info@leuze.de

The main menus

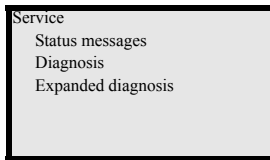
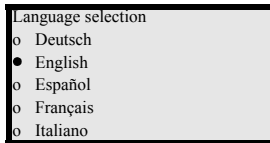
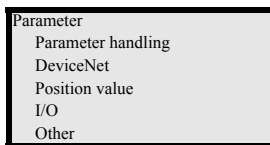
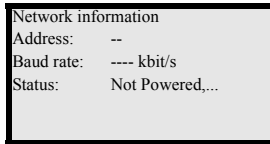

Device information - main menu

This menu item contains detailed information on

- Device type
- Manufacturer
- Software and hardware version
- Serial number

No entries can be made via the display.

Network information - main menu

Explanations of address, baud rate, status. No entries can be made via the display.

Status and measurement data - main menu

- Display of status, warning and error messages.
- Status overview of the switching inputs/ outputs
- Bar graph for the received signal level.
- Activated interface.
- Measurement value

No entries can be made via the display. See "Indicators in the display" on page 40.

Parameter - main menu

- Configuration of the AMS.

See "Parameter menu" on page 45.

Language selection - main menu

- Selection of the display language.

See "Language selection menu" on page 50.

Service - main menu

- Display of status messages.
- Display of diagnostic data.

No entries can be made via the display. See "Service menu" on page 50.

Device buttons:

- Navigate upward/sideways
- Navigate downward/sideways
- ESCAPE** leave
- ENTER** confirm

Input of values

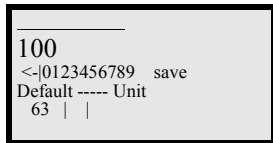

+ **Delete character**

... + **Enter digit**

save + **Save input**

- 1 General information 5**
- 1.1 Explanation of symbols 5
- 1.2 Declaration of Conformity 5
- 1.3 Description of functions AMS 355/ 6

- 2 Safety 7**
- 2.1 Intended use 7
- 2.2 Foreseeable misuse 8
- 2.3 Competent persons 8
- 2.4 Exemption of liability 9
- 2.5 Laser safety notices 9

- 3 Fast commissioning / operating principle 12**
- 3.1 Mounting the AMS 355/ 12
- 3.1.1 Mounting the device 12
- 3.1.2 Mounting the reflector 12
- 3.2 Connecting the voltage supply 13
- 3.3 Display 13
- 3.4 AMS 355/ on the DeviceNet 13

- 4 Technical data 14**
- 4.1 Technical data of laser measurement system 14
- 4.1.1 General specifications AMS 355/ 14
- 4.1.2 AMS 355/ dimensioned drawing 16
- 4.1.3 Overview of AMS 355/ types 17

- 5 Installation and mounting 18**
- 5.1 Storage, transportation 18
- 5.2 Mounting the AMS 355/ 19
- 5.2.1 Optional mounting bracket 21
- 5.2.2 Parallel mounting of the AMS 355/ 22
- 5.2.3 Parallel mounting of AMS 355/ and DDLS optical data transmission 23
- 5.3 Mounting the AMS 355/ with laser beam deflector unit 24
- 5.3.1 Mounting the laser beam deflector unit with integrated mounting bracket 24
- 5.3.2 Dimensioned drawing of US AMS 01 deflector unit 25
- 5.3.3 Mounting the US 1 OMS deflector unit without mounting bracket 26

6	Reflectors	27
6.1	General information	27
6.2	Description of the reflective tape	27
6.2.1	Technical data of self-adhesive tape	28
6.2.2	Technical data of reflective tape on carrier plate	28
6.2.3	Dimensioned drawing of reflective tape on carrier plate	29
6.2.4	Technical data of heated reflectors	30
6.2.5	Dimensioned drawing of heated reflectors	31
6.3	Selecting reflector size	32
6.4	Mounting the reflector	33
6.4.1	General information	33
6.4.2	Mounting the reflector	33
6.4.3	Table of reflector pitches	36
7	Electrical connection	37
7.1	Safety notices for the electrical connection	37
7.2	PWR – voltage supply / switching input/output	38
7.3	DeviceNet BUS IN	38
7.4	DeviceNet BUS OUT	39
7.5	Service	39
8	Display and control panel AMS 355/	40
8.1	Structure of the control panel	40
8.2	Status indicators and operation	40
8.2.1	Indicators in the display	40
8.2.2	LED status indicators	41
8.2.3	Control buttons	43
8.3	Menu description	44
8.3.1	The main menu	44
8.3.2	Parameter menu	45
8.3.3	Language selection menu	50
8.3.4	Service menu	50
8.4	Operation	51
9	DeviceNet interface	53
9.1	General information on DeviceNet	53
9.1.1	Topology	53
9.1.2	Communication	55

- 9.2 DeviceNet electrical connection 56
- 9.3 Electrical data for Data V+ and Data V- supply voltage 57
- 9.4 DeviceNet address entry - MAC ID 57
- 9.4.1 Entering the MAC ID (address) via the display 57
- 9.5 EDS file - general info 58
- 9.6 EDS file - detailed description 60
- 9.6.1 Class 4 Assembly 60
- 9.6.2 Class 1 Identity object 62
- 9.6.3 Class 35 Position sensor object 65
- 9.6.4 Class 100 Display configuration 71
- 9.6.5 Class 101 Assembly selection 73
- 9.6.6 Class 103 Switching inputs / outputs 75
- 9.6.7 Class 104 Error handling procedures 78
- 9.6.8 Class 105 Velocity monitoring 80

- 10 Diagnostics and troubleshooting 83**
- 10.1 Service and diagnosis in the display of the AMS 355/ 83
- 10.1.1 Status messages 83
- 10.1.2 Diagnosis 84
- 10.1.3 Expanded diagnosis 84
- 10.2 General causes of errors 85
- 10.2.1 Power LED 85
- 10.3 Interface errors 86
- 10.3.1 NET LED 86
- 10.4 Status indicators in the display of the AMS 355/ 86

- 11 Type overview and accessories 89**
- 11.1 Part number code 89
- 11.2 Overview of AMS 355/types (DeviceNet) 89
- 11.3 Overview of reflector types 90
- 11.4 Accessories 90
- 11.4.1 Accessories – Mounting bracket 90
- 11.4.2 Accessories – Deflector unit 90
- 11.4.3 Accessories – M12 connector 90
- 11.4.4 Accessories – Terminating resistor 91
- 11.4.5 Accessories – Ready-made cables for voltage supply 91
- 11.4.6 Accessories - Ready-made cables for DeviceNet 92

12	Maintenance	94
12.1	General maintenance information	94
12.2	Repairs, servicing	94
12.3	Disassembling, packing, disposing	94

1 General information

1.1 Explanation of symbols

The symbols used in this technical description are explained below.



Attention!

This symbol precedes text messages which must strictly be observed. Failure to observe the provided instructions could lead to personal injury or damage to equipment.



Attention Laser!

This symbol warns of possible danger through hazardous laser radiation.



Note!

This symbol indicates text passages containing important information.

1.2 Declaration of Conformity

The AMS 355*i* absolute measuring optical laser measurement system was designed and manufactured in accordance with the applicable European directives and standards.

The AMS series is "UL LISTED" according to American and Canadian safety standards and fulfills the requirements of Underwriter Laboratories Inc. (UL).



Note!

The Declaration of Conformity for these devices can be requested from the manufacturer.

The manufacturer of the product, Leuze electronic GmbH & Co. KG in D-73277 Owen, possesses a certified quality assurance system in accordance with ISO 9001.



1.3 Description of functions AMS 355*i*

The AMS 355*i* optical laser measurement system calculates distances to fixed as well as moving system parts. The distance to be measured is calculated according to the principle of the propagation time of radiated light. Here, the light emitted by the laser diode is reflected by a reflector onto the receiving element of the laser measurement system. The AMS 355*i* uses the "propagation time" of the light to calculate the distance to the reflector. The high absolute measurement accuracy of the laser measurement system and the fast response time are designed for position control applications.

With its AMS 3xx*i* product series, Leuze makes available a wide range of internationally relevant interfaces. Note that each interface version listed below corresponds to a different AMS 3xx*i* model.



AMS 304*i*



AMS 348*i*



AMS 355*i*



AMS 358*i*



AMS 335*i*



AMS 338*i*



AMS 308*i*



AMS 384*i*



AMS 301*i*



AMS 300*i*

2 Safety

This sensor was developed, manufactured and tested in line with the applicable safety standards. It corresponds to the state of the art.

2.1 Intended use

The AMS is an absolute measuring optical laser measurement system which allows distance measurement of up to 300m against a reflector.

Areas of application

The AMS is designed for the following areas of application:

- Positioning of automated, moving plant components
- Travel and lifting axes of high-bay storage devices
- Repositioning units
- Gantry crane bridges and their trolleys
- Elevators
- Electroplating plants

	CAUTION
<p>Observe intended use!</p> <p>☞ <i>Only operate the device in accordance with its intended use. The protection of personnel and the device cannot be guaranteed if the device is operated in a manner not complying with its intended use.</i></p> <p><i>Leuze electronic GmbH + Co. KG is not liable for damages caused by improper use.</i></p> <p>☞ <i>Read the technical description before commissioning the device. Knowledge of this technical description is an element of proper use.</i></p>	

NOTE	
<p>Comply with conditions and regulations!</p> <p>☞ <i>Observe the locally applicable legal regulations and the rules of the employer's liability insurance association.</i></p>	



Attention

For UL applications, use is only permitted in Class 2 circuits in accordance with the NEC (National Electric Code).

2.2 Foreseeable misuse

Any use other than that defined under "Intended use" or which goes beyond that use is considered improper use.

In particular, use of the device is not permitted in the following cases:

- in rooms with explosive atmospheres
- as stand-alone safety component in accordance with the machinery directive ¹⁾
- for medical purposes

NOTE

Do not modify or otherwise interfere with the device!

⚠ *Do not carry out modifications or otherwise interfere with the device.*

The device must not be tampered with and must not be changed in any way.

The device must not be opened. There are no user-serviceable parts inside.

Repairs must only be performed by Leuze electronic GmbH + Co. KG.

2.3 Competent persons

Connection, mounting, commissioning and adjustment of the device must only be carried out by competent persons.

Prerequisites for competent persons:

- They have a suitable technical education.
- They are familiar with the rules and regulations for occupational safety and safety at work.
- They are familiar with the technical description of the device.
- They have been instructed by the responsible person on the mounting and operation of the device.

Certified electricians

Electrical work must be carried out by a certified electrician.

Due to their technical training, knowledge and experience as well as their familiarity with relevant standards and regulations, certified electricians are able to perform work on electrical systems and independently detect possible dangers.

In Germany, certified electricians must fulfill the requirements of accident-prevention regulations DGUV (German Social Accident Insurance) provision 3 (e.g. electrician foreman). In other countries, there are respective regulations that must be observed.

¹⁾ Use as safety-related component within the safety function is possible, if the component combination is designed correspondingly by the machine manufacturer.

2.4 Exemption of liability

Leuze electronic GmbH + Co. KG is not liable in the following cases:

- The device is not being used properly.
- Reasonably foreseeable misuse is not taken into account.
- Mounting and electrical connection are not properly performed.
- Changes (e.g., constructional) are made to the device.

2.5 Laser safety notices



ATTENTION! LASER RADIATION – CLASS 2 LASER PRODUCT

Do not stare into beam!

The device satisfies the requirements of IEC 60825-1:2014 / EN 60825-1:2014+A11:2021 safety regulations for a product of **laser class 2** and complies with 21 CFR 1040.10 except for conformance with IEC 60825-1 Ed. 3., as described in Laser Notice No. 56, dated May 8, 2019.

- ☞ *Never look directly into the laser beam or in the direction of reflected laser beams!
If you look into the beam path over a longer time period, there is a risk of injury to the retina.*
- ☞ *Do not point the laser beam of the device at persons!*
- ☞ *Interrupt the laser beam using a non-transparent, non-reflective object if the laser beam is accidentally directed towards a person.*
- ☞ *When mounting and aligning the device, avoid reflections of the laser beam off reflective surfaces!*
- ☞ *CAUTION! The use of operating and adjustment devices other than those specified here or the carrying out of differing procedures may lead to dangerous exposure to radiation.*
- ☞ *Observe the applicable statutory and local laser protection regulations.*
- ☞ *The device must not be tampered with and must not be changed in any way.
There are no user-serviceable parts inside the device.
Repairs must only be performed by Leuze electronic GmbH + Co. KG.*

NOTE**Affix laser information and warning signs!**

Laser information and warning signs are attached to the device (see figure 2.1). Also included with the device are self-adhesive laser warning and laser information signs (stick-on labels) in multiple languages (see figure 2.2).

↪ *Affix the laser information sheet to the device in the language appropriate for the place of use.*

When using the device in the U.S.A., use the stick-on label with the "Complies with 21 CFR 1040.10" notice.

↪ *Affix the laser information and warning signs near the device if no signs are attached to the device (e.g. because the device is too small) or if the attached laser information and warning signs are concealed due to the installation position.*

Affix the laser information and warning signs so that they can be read without the reader being exposed to the laser radiation of the device or other optical radiation.

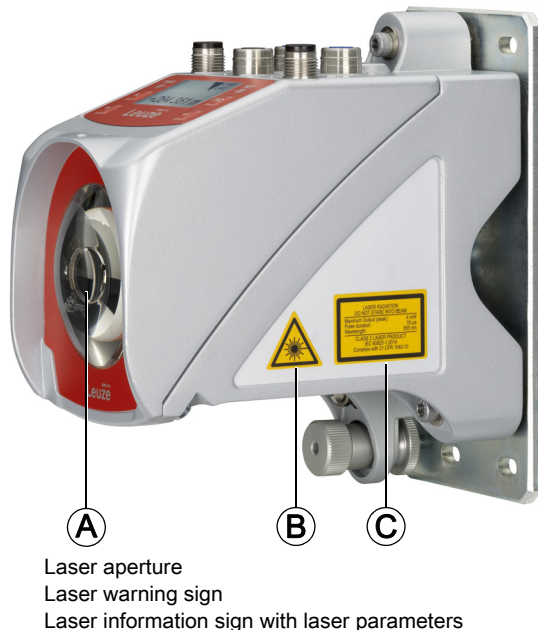

Figure 2.1: Laser apertures, laser warning signs

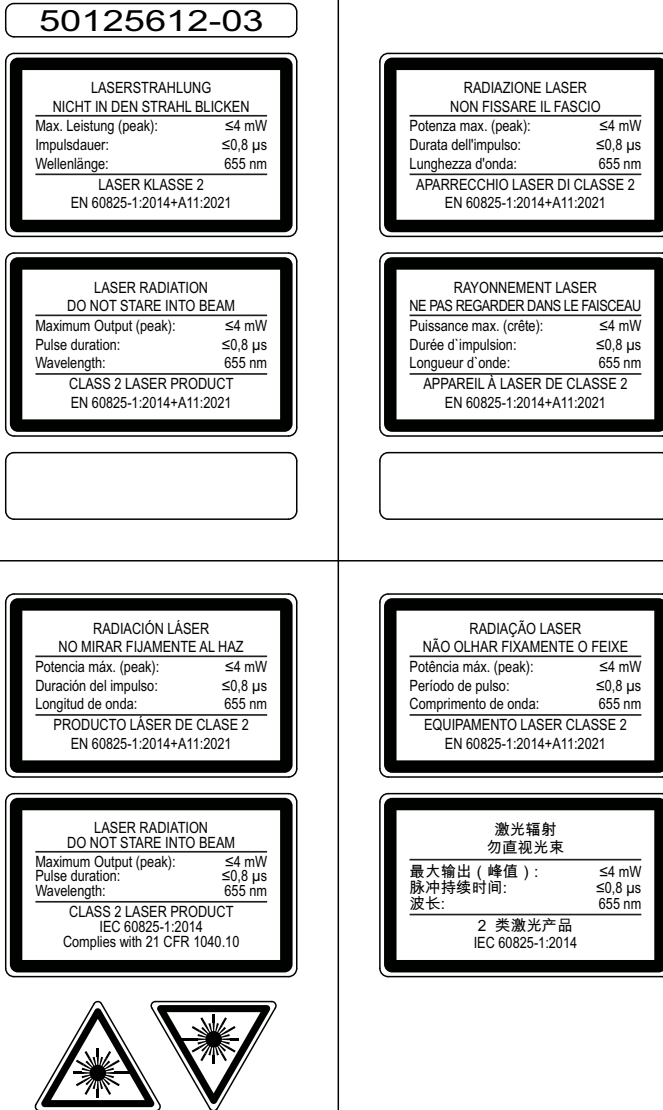

Figure 2.2: Laser warning and information signs – supplied stick-on labels

3 Fast commissioning / operating principle



Note!

Below you will find a **short description for the initial commissioning** of the AMS 355*i*. Detailed explanations for the listed points can be found throughout the handbook.

3.1 Mounting the AMS 355*i*

The AMS 355*i* and the corresponding reflector are mounted on two mutually opposing, plane-parallel, flat walls.



Figure 3.1: Schematic illustration of mounting



Attention!

For error-free position measurement, there must be an unobstructed line-of-sight between the AMS 355*i* and the reflector.

3.1.1 Mounting the device

The laser is mounted using 4 screws (M5).

Alignment is performed using 2 adjustment screws. Adjust so that the laser light spot is positioned at the center of the reflector. The alignment is secured with the knurled nut and locked with the M5 nut.

Detailed information can be found in Chapter 5.2 and Chapter 5.3.

3.1.2 Mounting the reflector

The reflector is mounted using 4 screws (M5). The reflector is angled using the spacer sleeves included. Incline the reflector by approx. 1°.

Detailed information can be found in Chapter 6.4.

3.2 Connecting the voltage supply

The laser measurement system is connected using M12 connectors. The voltage supply is connected via the PWR M12 connection.

Detailed information can be found in Chapter 7.

3.3 Display

Once the laser measurement system is supplied with voltage, the device status as well as the measured position values can be read on the display. The display automatically switches to the display of the measurement values.

Use the up/down buttons (▲ ▼) to the left of the display to read and change a wide range of data and parameters.

Depending on the connected interface, the network address must be configured via the display.

Detailed information can be found in Chapter 8.

3.4 AMS 355*i* on the DeviceNet

Install the EDS file that belongs to the AMS 355*i*..., in your planning tool/control (e.g. RS Networkx).



Note!

You can find the EDS file at www.leuze.com.

The AMS 355*i* is configured in the planning tool/control by means of the EDS file. If the AMS 355*i* has been assigned an address in the planning tool, the address must be set on the AMS 355*i* via the control panel/display. Only if the addresses are the same between the AMS 355*i* and the control can communication be established.

After all parameters have been set in the planning tool/control, the download to the AMS 355*i* takes place. The set parameters are now stored on the AMS 355*i*.

Afterwards, all AMS 355*i* parameters should be stored via upload in the control. This helps in retaining the parameters during device exchanges because the parameters are now also stored centrally in the control.

Each time a connection is established between the control and the AMS 355*i*, these parameters are now transmitted again to the AMS 355*i*. Note that this function must be supported by the control.

The DeviceNet baud rate is defined for the entire network in the planning tool/control.

On the AMS 355*i*, the baud rate is set via the control panel/display.

Communication with the AMS 355*i* is only possible if the baud rates match.

Detailed information can be found in Chapter 9.

4 Technical data

4.1 Technical data of laser measurement system

4.1.1 General specifications AMS 355/

Measurement data	AMS 355/40 (H)	AMS 355/120 (H)	AMS 355/200 (H)	AMS 355/300 (H)
Measurement range	0.2 ... 40m	0.2 ... 120m	0.2 ... 200m	0.2 ... 300m
Accuracy	± 2mm	± 2mm	± 3mm	± 5mm
Reproducibility ¹⁾	0.3mm	0.5mm	0.7mm	1.0mm
Light spot diameter	≤ 40mm	≤ 100mm	≤ 150mm	≤ 225mm
Output time			1.7 ms	
Response time			14ms	
Basis for contouring error calculation			7ms	
Resolution	Adjustable; see chapters on individual interfaces			
Temperature drift			≤ 0.1mm/K	
Ambient temperature sensitivity			1 ppm/K	
Air pressure sensitivity			0.3ppm/hPa	
Traverse rate			≤ 10m/s	
Electrical data				
Supply voltage V_{in} ²⁾			18 ... 30VDC	
Data V+ supply voltage			11 ... 25VDC	
Data V- supply voltage			Reference potential	
Current consumption AMS 355/ at Data V+			Max. 80mA at 11VDC	
Current consumption			(for supplying the bus transceiver, not for the complete device) Without device heating: ≤ 250mA / 24VDC With device heating: ≤ 500mA / 24VDC	
Optical data				
Transmitter			Laser diode, red light	
Laser class			2 in acc. with IEC 60825-1:2014 / EN 60825-1:2014+A11:2021	
Wavelength			655nm	
Impulse duration			≤ 0.8µs	
Max. output power (peak)			≤ 4mW	
Interfaces				
DeviceNet			125kbit/s (default) / 250kbit/s / 500kbit/s	
Vendor ID			524 _{Dez} / 20C _H	
Device type			34 _{Dez} / 22 _H (encoder)	
Position sensor type			8 _{Dez} / 8 _H (absolute encoder)	
Controls and indicators				
Keyboard			4 keys	
Display			Monochromatic graphical display, 128 x 64 pixels	
LED			2 LEDs, two-colored	

Inputs/outputs

Quantity	2, programmable
Input	Protected against polarity reversal
Output	Max. 60 mA, short-circuit-proof

Mechanical data

Housing	Diecast zinc/aluminum
Optics	Glass
Weight	Approx. 2.45 kg
Degree of protection	IP 65 acc. to EN 60529 ³⁾

Environmental conditions

Operating temperature	
without device heating	-5°C ... +50°C
with device heating	-30°C ... +50°C ⁴⁾
Storage temperature	-30°C ... +70°C
Air humidity	Max. 90% rel. humidity, non-condensing
MTTF	31 years (at 25 °C) ⁵⁾

Mechanical/electrical loading capacity

Vibration	Acc. to EN 60068-2-6
Noise	Acc. to EN 60060-2-64
Shock	Acc. to EN 60068-2-27
EMC	Acc. to EN 61000-6-2 and EN 61000-6-4 ⁶⁾

- 1) Statistical error: 1 sigma; minimum switch-on time: 2min.
- 2) For UL applications: only for use in "Class 2" circuits according to NEC.
- 3) With screwed-on M12 connectors or mounted caps.
- 4) With devices with heating, the switch on/off area of the internal heating can be extended to prevent condensation from forming. Total prevention of condensation cannot be guaranteed due to the limited heating capacity of the AMS 355*i*.
- 5) We reserve the right to make changes. (Value is updated at regular intervals.)
- 6) This is a Class A product. In a domestic environment this product may cause radio interference, in which case the operator may be required to take adequate measures.



The AMS 355*i* is designed in accordance with protection class III for supply with PELV (protective extra-low voltage).

4.1.2 AMS 355/*i* dimensioned drawing

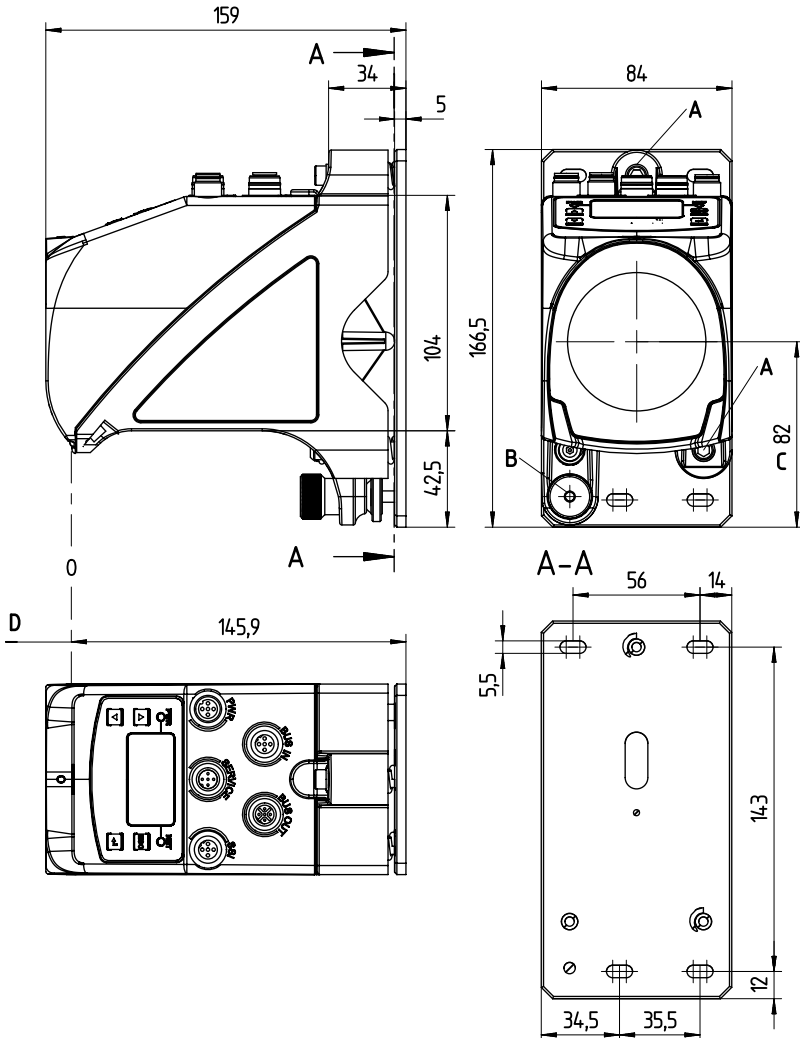

- A M 5 screw for alignment
- B Knurled nut with WAF4 hexagon socket and M5 nut for securing
- C Optical axis
- D Zero point of the distance to be measured

Figure 4.1: AMS 355/*i* dimensioned drawing

4.1.3 Overview of AMS 355/*i*types

AMS 355/*i*(DeviceNet)

Type designation	Description	Part no.
AMS 355/ <i>i</i> 40	40m operating range, DeviceNet interface	50113717
AMS 355/ <i>i</i> 120	120m operating range, DeviceNet interface	50113718
AMS 355/ <i>i</i> 200	200m operating range, DeviceNet interface	50113719
AMS 355/ <i>i</i> 300	300m operating range, DeviceNet interface	50113720
AMS 355/ <i>i</i> 40 H	40m operating range, DeviceNet interface, integrated heating	50113721
AMS 355/ <i>i</i> 120 H	120m operating range, DeviceNet interface, integrated heating	50113722
AMS 355/ <i>i</i> 200 H	200m operating range, DeviceNet interface, integrated heating	50113723
AMS 355/ <i>i</i> 300 H	300m operating range, DeviceNet interface, integrated heating	50113724

Table 4.1: Overview of AMS 355/*i*types

5 Installation and mounting

5.1 Storage, transportation



Attention!

Package the device for transport and storage in such a way that is protected against shock and humidity. Optimum protection is achieved when using the original packaging. Ensure compliance with the approved environmental conditions listed in the specifications.

Unpacking

- ↳ Check the packaging content for any damage. If damage is found, notify the post office or shipping agent as well as the supplier.
- ↳ Check the delivery contents using your order and the delivery papers:
 - Delivered quantity
 - Device type and model as indicated on the name plate
 - Brief manual

The name plate provides information as to what AMS 355*i* type your device is. For specific information, please refer to Chapter 11.2.

Name plates

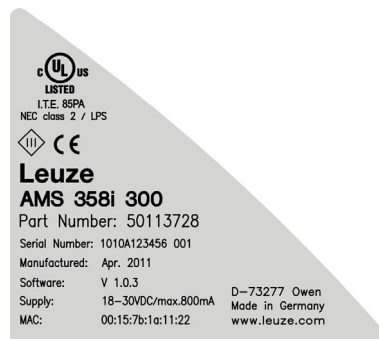

Figure 5.1: Device name plate using the AMS 358*i* as an example



Note!

Please note that the shown name plate is for illustration purposes only; the contents do not correspond to the original.

- ↳ Save the original packaging for later storage or shipping.

If you have any questions concerning your shipment, please contact your supplier or your local Leuze sales office.

👉 *Observe the applicable local regulations when disposing of the packaging materials.*

5.2 Mounting the AMS 355*i*

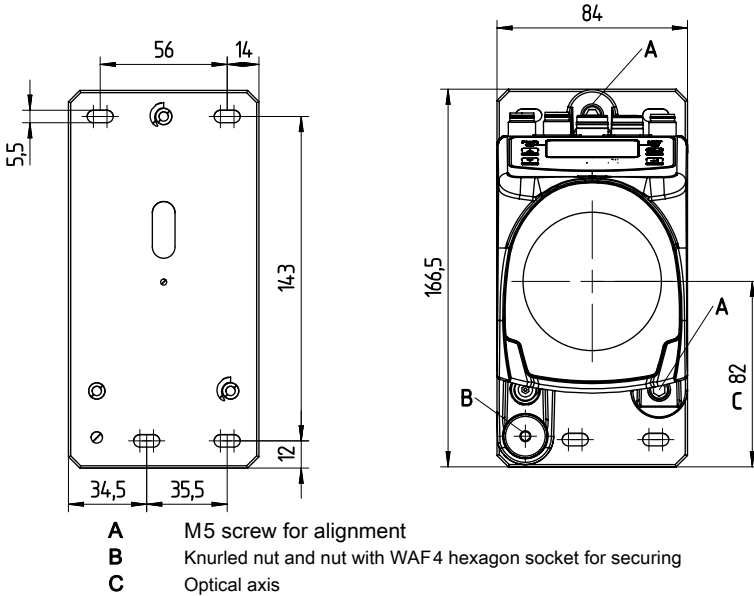

Figure 5.2: Mounting the device

The AMS 355*i* and the corresponding reflector are mounted on two mutually opposing, plane-parallel, flat walls or system parts. For error-free position measurement, there must be an unobstructed line-of-sight between the AMS 355*i* and the reflector.

Use M5 screws to fasten the laser measurement system. Secure the screws with a lock washer to protect against loosening caused by vibrations.

Aligning the laser light spot with the center of the reflector

The laser light spot has to be aligned so that it always hits the center of the opposing reflector, both at close range as well as at the maximum measurement distance. **To align, use the two M5 Allen screws ("A" in Figure 5.2).** When aligning, please ensure that the knurled nut and the lock nut ("B" in Figure 5.2) are opened wide.

**Attention!**

To prevent the laser measurement system from moving out of alignment during continuous operation, subsequently hand-tighten the knurled nut and counterlock with the nut with WAF4 hexagon socket ("B" in Figure 5.2). Knurled nut and nut must not be tightened until alignment has been completed.

**Attention!**

The device must not be opened. Failure to comply will render the guarantee void. Warranted features cannot be guaranteed after the device has been opened.

5.2.1 Optional mounting bracket

A mounting bracket for mounting the AMS 355/i on a flat, horizontal surface is available as an optional accessory.

Type designation: MW OMS/AMS 01

Part no.: 50107255

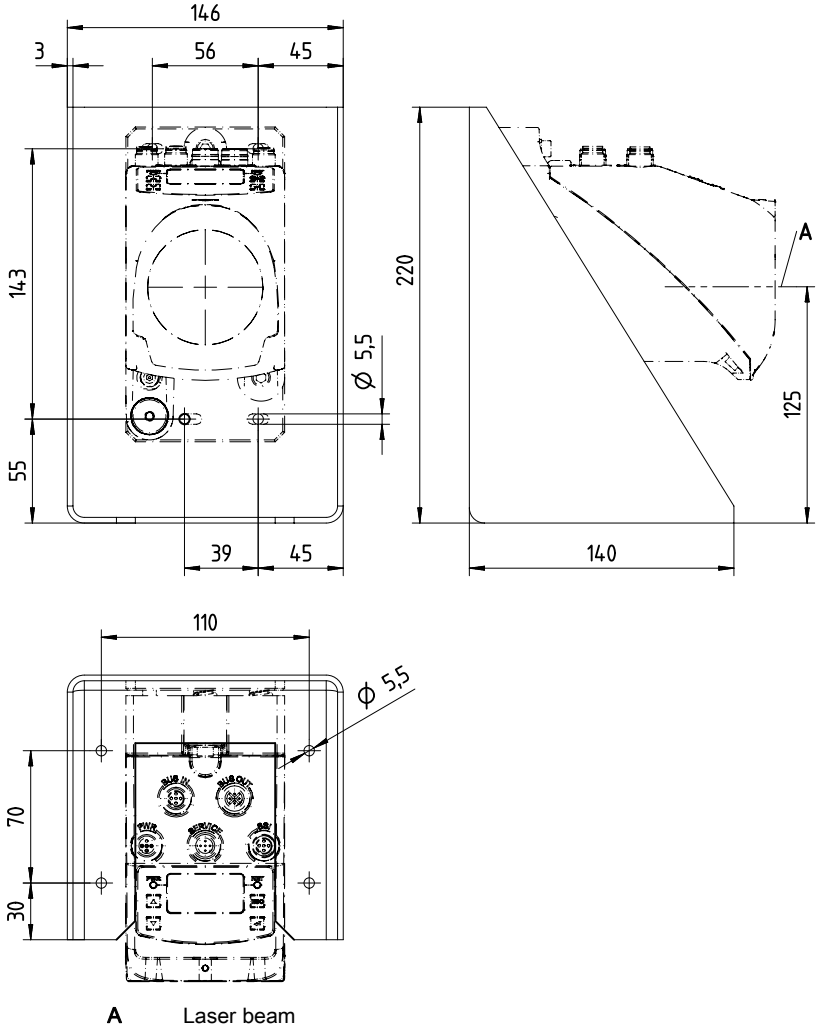

Figure 5.3: Optional mounting bracket

5.2.2 Parallel mounting of the AMS 355/

Definition of the term "parallel spacing"

As shown in Figure 5.4, dimension X describes the "parallel spacing" of the inner edges of the two laser light spots on the reflector.

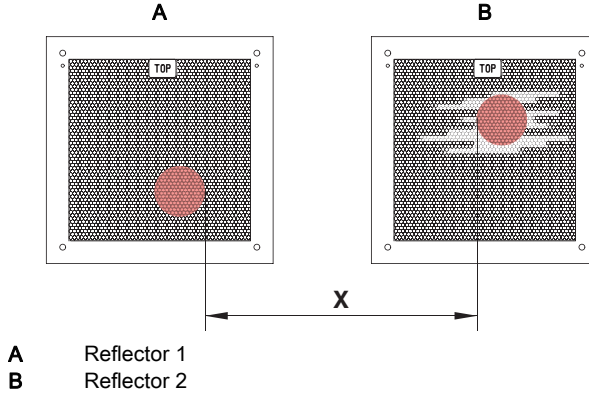

Figure 5.4: Minimum parallel spacing X between adjacent AMS 355/

The diameter of the light spot increases with distance.

	AMS 355/40 (H)	AMS 355/120 (H)	AMS 355/200 (H)	AMS 355/300 (H)
Max. measurement distance	40m	120m	200m	300m
Light spot diameter	≤ 40mm	≤ 100mm	≤ 150mm	≤ 225mm

Thus, the center-to-center spacing of the two AMS 355/ devices with respect to one another can be calculated as a function of the maximum measurement distance.

To define the minimum parallel spacing between two AMS 355/, it is necessary to distinguish between three different arrangements of AMS 355/ and reflectors.

The AMS 355/ are mounted stationary and in parallel on one plane.

Both reflectors move independently of one another at different distances to the AMS 355/.

Minimum parallel spacing X of the two laser light spots:

$$X = 100\text{mm} + (\text{max. measurement distance in mm} \times 0.01)$$

The AMS 355/ are mounted stationary and in parallel on one plane.

Both reflectors move in parallel at the same distance to the AMS 355/.

Measurement distance up to 120m: minimum parallel spacing X ≥ 600mm

Measurement distance up to 200m: minimum parallel spacing X ≥ 750mm

Measurement distance up to 300m: minimum parallel spacing X ≥ 750mm

The reflectors are mounted stationary and in parallel on one plane.

Both AMS 355*i* move independently of one another at different or the same distances to the reflectors.

Measurement distance up to 120m: minimum parallel spacing $X \geq 600\text{mm}$

Measurement distance up to 200m: minimum parallel spacing $X \geq 750\text{mm}$

Measurement distance up to 300m: minimum parallel spacing $X \geq 750\text{mm}$



Note!

*Please note that when the AMS 355*i* are mounted in a mobile manner, travel tolerances could cause the two laser light spots to move towards each other.*

*Take the travel tolerances of the vehicle into account when defining the parallel spacing of adjacent AMS 355*i*.*

5.2.3 Parallel mounting of AMS 355*i* and DDLS optical data transmission

The optical data transceivers of the DDLS series and the AMS 355*i* do not interfere with one another. Depending on the size of the used reflector, the DDLS can be mounted with a minimum parallel spacing of 100mm to the AMS 355*i*. The parallel spacing is independent of the distance.

5.3 Mounting the AMS 355*i* with laser beam deflector unit

General information

The two available deflector units are used for the 90° deflection of the laser beam, see "Accessories – Deflector unit" on page 90.



Attention!

The deflector units are designed for a maximum range of 40m. Longer distances on request.

5.3.1 Mounting the laser beam deflector unit with integrated mounting bracket

The AMS 355*i* is screwed onto the mechanism of the US AMS 01 deflector unit. The mirror can be mounted for three deflection directions:

1. Upward beam deflection
2. Beam deflection to the left
3. Beam deflection to the right

The deflector unit is mounted on plane-parallel, flat walls or system parts. For error-free position measurement, there must be an unobstructed line-of-sight between the AMS 355*i*... and the deflection mirror as well as between the mirror and the reflector.

Use the M5 screws to mount the deflector unit. Secure the screws with a lock washer to protect against loosening caused by vibrations.



Figure 5.5: Mounting variants of the US AMS 01 laser beam deflector unit

5.3.2 Dimensioned drawing of US AMS 01 deflector unit

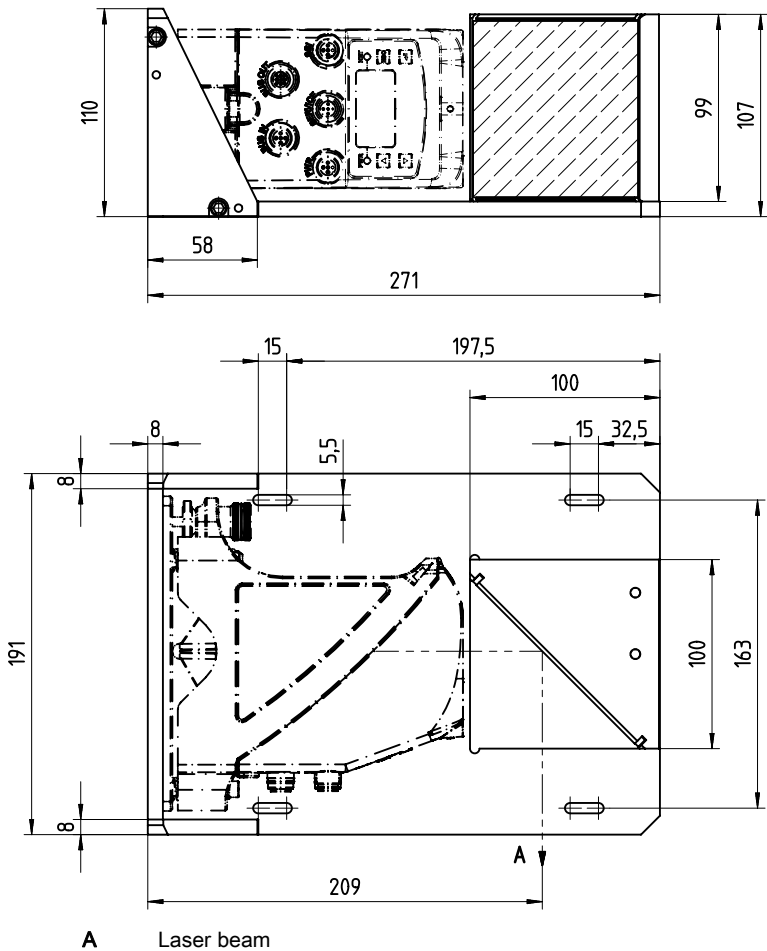

Figure 5.6: Dimensioned drawing of US AMS 01 deflector unit

5.3.3 Mounting the US 1 OMS deflector unit without mounting bracket

The US 1 OMS deflector unit and the AMS 355*i* are mounted separately.



Note!

When mounting, make certain that the laser light spot of the AMS 355*i* is aligned with the center of the deflection mirror.

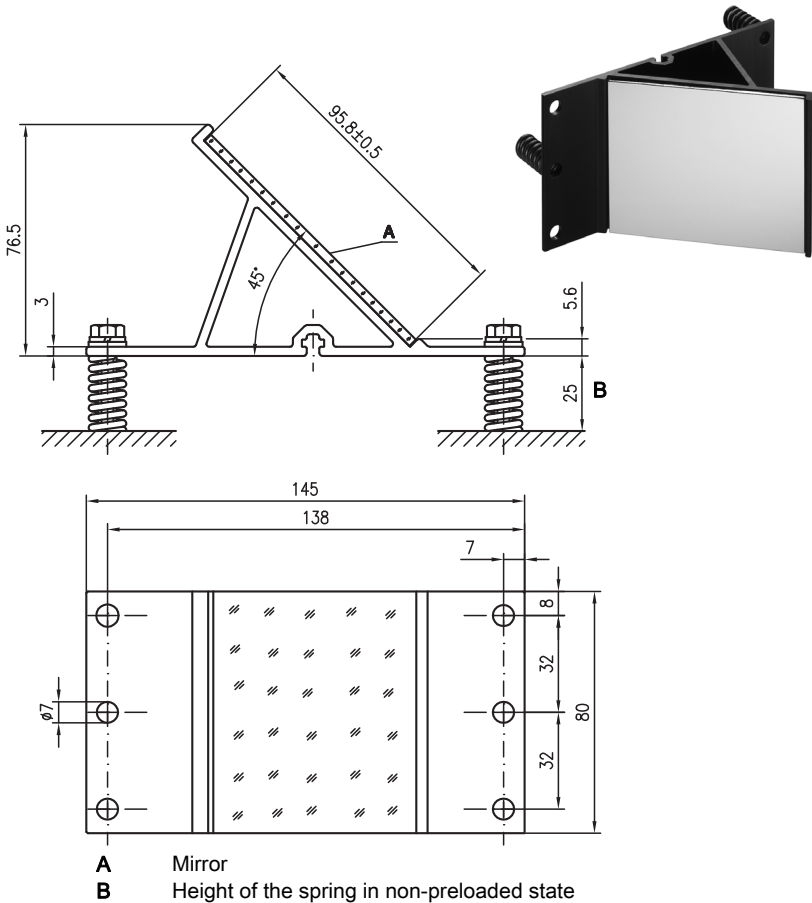

Figure 5.7: Photo and dimensioned drawing of the US 1 OMS deflector unit

The laser light spot is aligned with the reflector as described in Chapter 5.2.

6 Reflectors

6.1 General information

The AMS 355*i* measures distances against a reflective tape specified by Leuze. All technical data given for the AMS 355*i*, such as the operating range or accuracy, can only be achieved with the reflective tape specified by Leuze.

The reflective tapes are available as self-adhesive tapes or affixed to a carrier plate and with an integrated heater especially for use at low temperatures. Reflective tapes with heating have the designation "**Reflective tape ...x...-H**", where "**H**" is an abbreviation for the heating variant.

The reflective tapes/reflectors must be ordered separately. The choice of size is left to the user. In Chapter 6.3, recommendations on reflector size are given depending on the distance that is to be measured. In each case, the user must check whether the recommendation is suitable for the respective application.

6.2 Description of the reflective tape

The reflective tape consists of a white, microprism-based reflective material. The microprisms are protected by a hard, highly transparent protective layer.

Under certain circumstances, the protective layer can cause surface reflections. The surface reflections can be directed past the AMS 355*i* by positioning the reflective tape at a slight incline. The inclination of the reflective tape/reflectors is described in Chapter 6.4.2. The required pitch can be found in Table 6.1 "Reflector pitch resulting from spacer sleeves" on page 36.

The reflective tapes have a protective film that is easy to peel off. It must be removed from the reflector before the complete system is put into operation.

6.2.1 Technical data of self-adhesive tape

	Article				
Type designation	Reflective tape 200x200-S	Reflective tape 500x500-S	Reflective tape 914x914-S	REF 4-A- 150x150	REF 4-A- 300x300
Part no.	50104361	50104362	50108988	50141015	50141014
Film size	200 x 200 mm	500 x 500 mm	914x914 mm	150 x 150 mm	300 x 300 mm
Recommended application temperature for adhesive tape	+5°C ... +25°C				
Temperature resistance, affixed	-40°C ... +80°C				
Bonding surface	The bonding surface must be clean, dry and free of grease.				
Cutting tape	Cut with a sharp tool, always on the side with the prism structure.				
Cleaning	Do not use any abrasive agents. A conventional household detergent can be used as a cleaning agent. Rinse with clear water and dry the surface.				
Film storage	Store in a cool and dry place.				

6.2.2 Technical data of reflective tape on carrier plate

The reflective tape is affixed to a carrier plate. Included with the carrier plate are spacers for positioning at an incline in order to avoid surface reflections (see chapter 6.4.2 "Mounting the reflector").

	Article		
Type designation	Reflective tape 200x200-M	Reflective tape 500x500-M	Reflective tape 914x914-M
Part no.	50104364	50104365	50104366
Film size	200 x 200 mm	500 x 500 mm	914x914 mm
Outer dimensions of carrier plate	250 x 250 mm	550 x 550 mm	964 x 964 mm
Weight	0.4 kg	1.6 kg	6 kg
Cleaning	Do not use any abrasive agents. A conventional household detergent can be used as a cleaning agent. Rinse with clear water and dry the surface.		
Reflector storage	Store in a cool and dry place.		

6.2.3 Dimensioned drawing of reflective tape on carrier plate

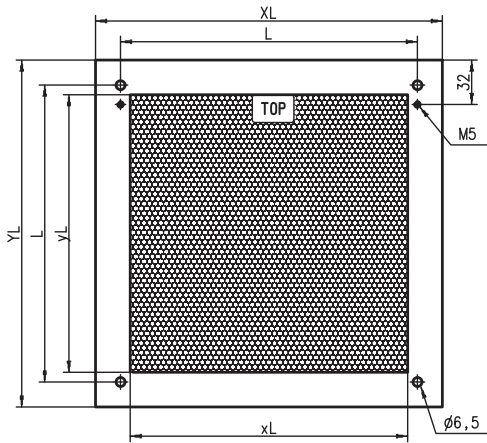

 Always align the **TOP** marking with the AMS connections! (Chapter 6.4.2)

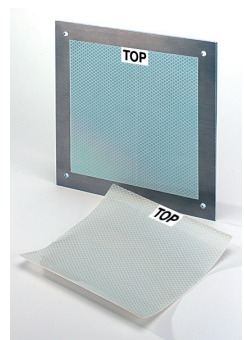

Figure 6.1: Dimensioned drawing of reflectors

Article	Reflective tape (mm)		Reflector plate (mm)		
	xL	yL	XL	YL	L
Reflective tape 200x200-M	200	200	250	250	214
Reflective tape 500x500-M	500	500	550	550	514
Reflective tape 914x914-M	914	914	964	964	928

6.2.4 Technical data of heated reflectors

The reflective tape is affixed to a heated, thermally insulated carrier. The insulation results in a very high energetic efficiency.

Only the reflective tape is kept at the specified temperature by the integrated heater. The insulation on the back prevents the generated heat from being dissipated via the steel construction. Energy costs are greatly reduced in the case of continuous heating.

Type designation	Article		
	Reflective tape 200x200-H	Reflective tape 500x500-H	Reflective tape 914x914-H
Part no.	50115020	50115021	50115022
Voltage supply	230VAC		
Power	100W	600W	1800W
Current consumption	~ 0.5A	~ 3A	~ 8A
Length of supply line	2 m		
Size of reflective tape	200 x 200mm	500 x 500mm	914 x 914mm
Outer dimensions of base material	250 x 250mm	550 x 550mm	964 x 964mm
Weight	0.5kg	2.5kg	12kg
Temperature control	Controlled heating with the following switch-on and switch-off temperatures, measured at the reflector surface.		
Switch-on temperature	~ 5°C		
Switch-off temperature	~ 20°C		
Operating temperature	-30°C ... +70°C		
Storage temperature	-40°C ... +80°C		
Air humidity	Max. 90%, non-condensing		
Cleaning	Do not use any abrasive agents. A conventional household detergent can be used as a cleaning agent. Rinse with clear water and dry the surface.		
Reflector storage	Store in a cool and dry place.		

6.2.5 Dimensioned drawing of heated reflectors

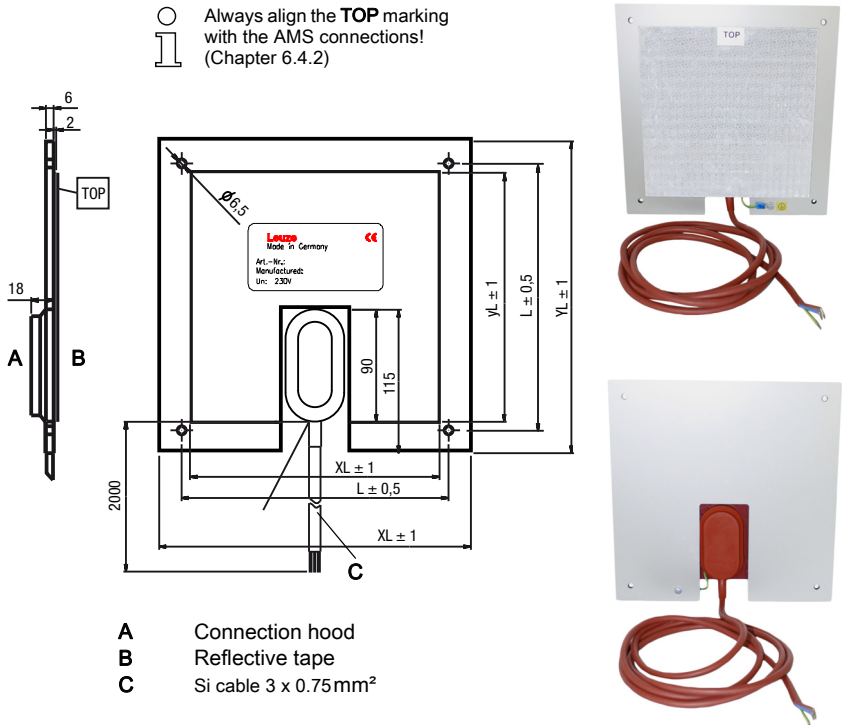

Figure 6.2: Dimensioned drawing of heated reflectors

Article	Reflective tape (mm)		Insulated carrier plate (mm)		
	xL	yL	XL	YL	L
Reflective tape 200x200-H	200	200	250	250	214
Reflective tape 500x500-H	500	500	550	550	514
Reflective tape 914x914-H	914	914	964	964	928

6.3 Selecting reflector size

Depending on the system design, the reflector can be mounted so that it moves with the vehicle or it can be mounted at a fixed location.



Attention!

The reflector sizes shown below are a recommendation from Leuze for on-vehicle mounting of the AMS 355*i*. For stationary mounting of the AMS 355*i*, a smaller reflector is generally sufficient for all measurement distances. For this reason, two smaller reflector sizes are available in the self-adhesive variant "-S".

During system planning and design, always check whether mechanical travel tolerances require the use of a reflector larger than that which is recommended. This applies, in particular, when the laser measurement system is mounted on a vehicle. During travel, the laser beam must reach the reflector unobstructed. For on-vehicle mounting of the AMS 355*i*, the reflector size must accommodate any travel tolerances that may arise and the associated "wandering" of the light spot on the reflector.

Overview of reflector types

Recommended reflector size			
Selected AMS 355 <i>i</i> (operating range in m)	Recommended reflector size (H x W)	Type designation ...-S = self-adhesive ...-M = Carrier plate ...-H = heating	Part no.
AMS 355 <i>i</i> 40 (max. 40m)	200x200mm	REF 4-A-150x150 ¹⁾ Reflective tape 200x200-S Reflective tape 200x200-M Reflective tape 200x200-H REF 4-A-300x300 ¹⁾	50141015 50104361 50104364 50115020 50141014
AMS 355 <i>i</i> 120 (max. 120m)	500x500mm	Reflective tape 500x500-S Reflective tape 500x500-M Reflective tape 500x500-H	50104362 50104365 50115021
AMS 355 <i>i</i> 200 (max. 200m)	749x914mm 914x914mm	Reflective tape 749x914-S Reflective tape 914x914-M Reflective tape 914x914-S Reflective tape 914x914-H	50104363 50104366 50108988 50115022
AMS 355 <i>i</i> 300 (max. 300m)	749x914mm 914x914mm	Reflective tape 749x914-S Reflective tape 914x914-M Reflective tape 914x914-S Reflective tape 914x914-H	50104363 50104366 50108988 50115022

1) For roadside mounting

6.4 Mounting the reflector

6.4.1 General information

Self-adhesive reflective tapes

The reflective tapes of the "Reflective tape ...x...-S" series (self-adhesive) must be affixed to a flat, clean and grease-free surface. We recommend using a separate carrier plate, which is to be provided on-site.

As described in Table 6.1, the reflective tape must be at an angle.

Reflective tapes on carrier plate

The reflective tapes of the "Reflective tape ...x...-M" series have corresponding mounting holes. Spacer sleeves are provided to enable mounting at the necessary pitch angle. For further information, see Table 6.1.

Heated reflectors

The reflective tapes of the "Reflective tape ...x...-H" series have corresponding mounting holes. Due to the voltage supply affixed on the rear, the reflector cannot be mounted flat. Four spacer sleeves in two different lengths are supplied. Use the spacer sleeves to ensure separation from the wall as well as to provide the necessary pitch for avoiding surface reflection. For further information, see Table 6.1.

The reflector has a 2m-long connection cable for supplying with 230VAC. Connect the cable to the nearest power distribution point. Observe the current consumptions listed in the technical data.



Attention!

Connection work must be carried out by a certified electrician.

6.4.2 Mounting the reflector

The combination of laser measurement system and reflective tape/reflector is mounted so that the laser light spot hits the film as centered as possible and without obstruction.

For this purpose, use the alignment elements provided on the AMS 355*i*... (see chapter 5.2 "Mounting the AMS 355"). If necessary, remove the protective film from the reflector.



Attention!

The "TOP" label on the reflectors should be aligned the same as the connections of the AMS 355*i*.

Example:

*If the AMS 355*i* is mounted so that the M12 connections are on the top, the "TOP" label of the reflector is also on the top. If the AMS 355*i* is mounted so that the M12 connections are on the side, the "TOP" label of the reflector is also on the side.*



Note!

The reflector must be positioned at an angle. Use the spacer sleeves for this purpose. Angle the reflector so that the **surface reflections of the foil seal are deflected to the left, right or upwards**. Chapter 6.4.3 gives the correct pitch with respect to the reflector size and, thus, the length of the spacers.

Reflective tapes ...-S and ...-M

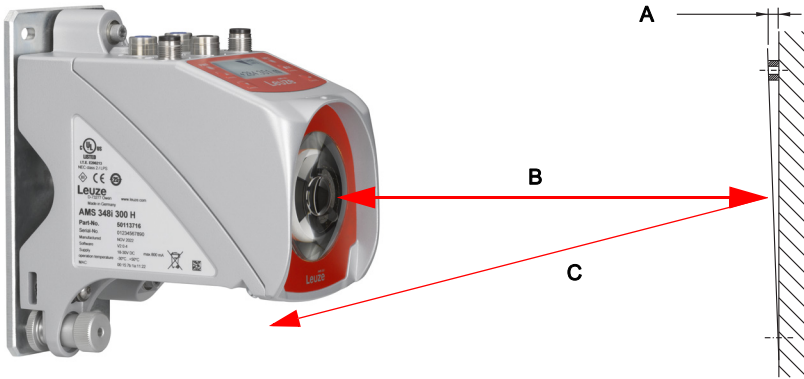

- A** Pitch approx. 1°
- B** Direct reflection due to the triple structure
- C** Deflected surface reflection due to the pitch of the reflective tape

Figure 6.3: Mounting the reflector

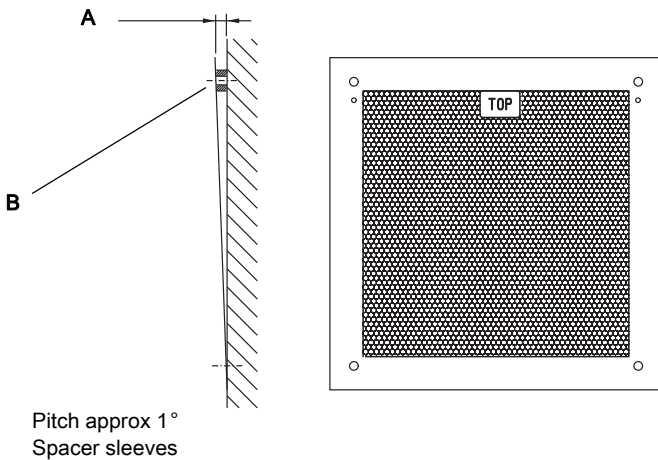

- A** Pitch approx 1°
- B** Spacer sleeves

Figure 6.4: Pitch of the reflector

Reflective tapes ...-H

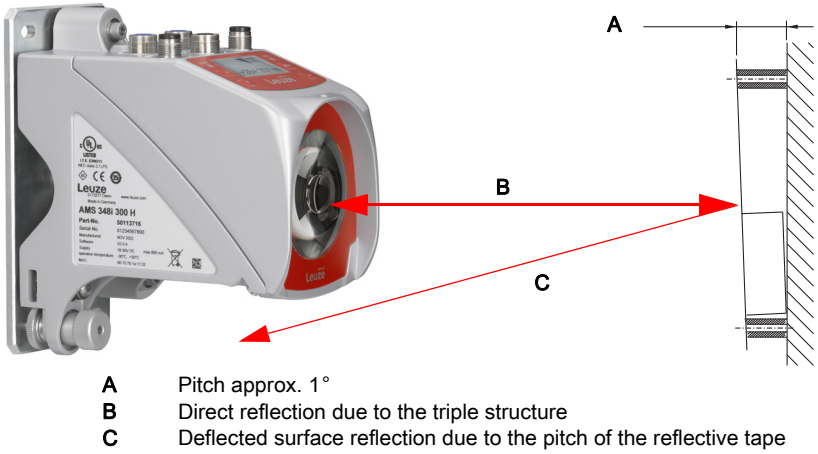

Figure 6.5: Mounting of heated reflectors

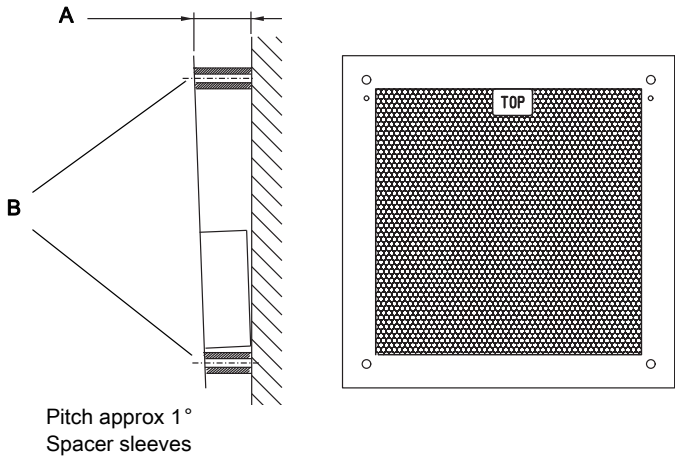

Figure 6.6: wPitch of the heated reflector

6.4.3 Table of reflector pitches

Reflector type	Pitch resulting from spacer sleeves ¹⁾	
Reflective tape 200x200-S Reflective tape 200x200-M	2 x 5mm	
Reflective tape 200x200-H	2 x 15mm	2 x 20mm
Reflective tape 500x500-S Reflective tape 500x500-M	2 x 10mm	
Reflective tape 500x500-H	2 x 15mm	2 x 25mm
Reflective tape 749x914-S	2 x 20mm	
Reflective tape 914x914-S Reflective tape 914x914-M	2 x 20mm	
Reflective tape 914x914-H	2 x 15mm	2 x 35mm

1) Spacer sleeves are included with reflective tape ...-M and ...-H

Table 6.1: Reflector pitch resulting from spacer sleeves



Note!

Reliable operation of the AMS 355*i* and, thus, max. operating range and accuracy can only be achieved with the reflective tape specified by Leuze. Correct operation cannot be guaranteed if other reflectors are used!

7 Electrical connection

The AMS 355*i* laser measurement systems are connected using variously coded M12 connectors. This ensures unique connection assignments.



Note!

The corresponding mating connectors and ready-made cables are available as accessories for all connections. For further information, see chapter 11 "Type overview and accessories".

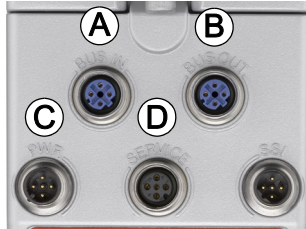

- A BUS IN, M12 connector (A-coded)
- B BUS OUT, M12 socket (A-coded)¹
- C PWR / IOs, M12 connector (A-coded)
- D Leuze SERVICE, M12 socket (A-coded)

Figure 7.1: Connections of the AMS 355*i*

7.1 Safety notices for the electrical connection



Attention!

Before connecting the device, be sure that the supply voltage agrees with the value printed on the name plate.

The device may only be connected by a qualified electrician.

Ensure that the functional earth (FE) is connected correctly. Unimpaired operation is only guaranteed when the functional earth is connected properly.

If faults cannot be cleared, the device should be switched off and protected against accidental use.



Attention!

For UL applications, use is only permitted in Class 2 circuits in accordance with the NEC (National Electric Code).



The laser measurement systems are designed in accordance with protection class III for supply by PELV (protective extra-low voltage with reliable disconnection).

1. According to DeviceNet specification (Volume 3: DeviceNet Adaptation of CIP Chapter 8, Physical Layer 8-3.3 Connectors), use of the BUS OUT connection is not allowed.

**Note!**

Degree of protection IP65 is achieved only if the connectors and caps are screwed into place!

Described in detail in the following are the individual connections and pin assignments.

7.2 PWR – voltage supply / switching input/output

PWR (5-pin connector, A-coded)			
	Pin	Name	Comment
	1	VIN	Positive supply voltage +18 ... +30VDC
	2	I/O 1	Switching input/output 1
	3	GNDIN	Negative supply voltage 0VDC
	4	I/O 2	Switching input/output 2
	5	FE	Functional earth
Thread	FE	Functional earth (housing)	

Table 7.1: Pin assignments - PWR

Further information on configuring the input/output can be found in Chapter 8 and Chapter 9.

7.3 DeviceNet BUS IN

BUS IN (5-pin connector, A-coded)			
	Pin	Name	Comment
	1	Drain	Shield
	2	V+	Data V+ supply voltage
	3	V-	Data V- supply voltage
	4	CAN_H	Data signal CAN_H
	5	CAN_L	Data signal CAN_L
Thread	FE	Functional earth (housing)	

Table 7.2: DeviceNet BUS IN pin assignment

7.4 DeviceNet BUS OUT

BUS OUT (5-pin socket, A-coded)			
	Pin	Name	Comment
	1	Drain	Shield
	2	V+	Data V+ supply voltage
	3	V-	Data V- supply voltage
	4	CAN_H	Data signal CAN_H
	5	CAN_L	Data signal CAN_L
	Thread	FE	Functional earth (housing)

Table 7.3: DeviceNet BUS OUT pin assignment



Attention!

According to DeviceNet specification (Volume 3: DeviceNet Adaptation of CIP Chapter 8, Physical Layer 8-3.3 Connectors), use of the BUS OUT connection is not allowed.

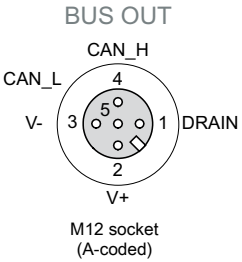
7.5 Service

Service (5-pin socket, A-coded)			
	Pin	Name	Comment
	1	NC	Not assigned
	2	RS232-TX	Transmission line RS 232/service data
	3	GND	Voltage supply 0VDC
	4	RS232-RX	Receiving line RS 232/service data
	5	NC	Not used
	Thread	FE	Functional earth (housing)

Table 7.4: Pin assignment - Service



Note!

The service interface is designed only for use by Leuze!

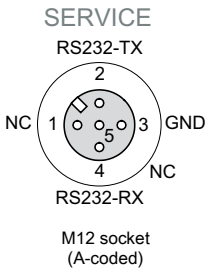
8 Display and control panel AMS 355*i*

8.1 Structure of the control panel

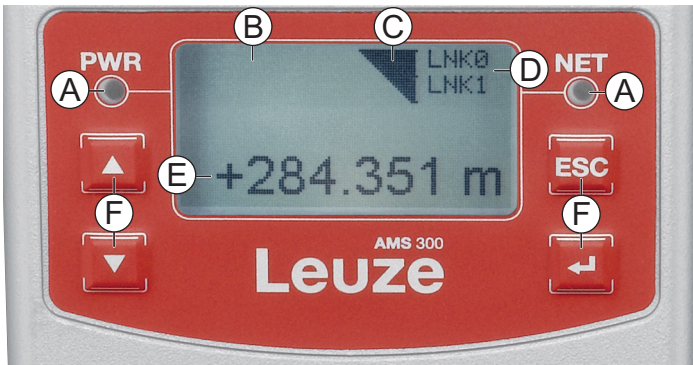

- A LED
- B Status indicator
- C Bargraph
- D Bus/interface info
- E Distance measurement value
- F Control buttons

Figure 8.1: Structure of the control panel using the AMS 304/*PROFIBUS* device variant as an example

8.2 Status indicators and operation

8.2.1 Indicators in the display

Status and warning messages in the display

- IO1 **Input 1 or output 1 active:**
Function depending on configuration.
- IO2 **Input 2 or output 2 active:**
Function depending on configuration.
- LSR **Warning - laser prefailure message:**
Laser diode old, device still functional, exchange or have repaired.
- TMP **Warning - temperature monitoring:**
Internal device temperature above/below permissible range.
- PLB **Plausibility error:**
Implausible measurement value. Possible causes: light beam interruption, outside of measurement range, permissible internal device temperature considerably exceeded or traverse rate >10m/s.

Depending on the configuration, either zero or the last valid measurement value is output at the interfaces.

ATT Warning - received signal:
Laser exit window or reflector soiled or fogged by rain, water vapor or fog. Clean or dry surfaces.

ERR Internal hardware error:
The device must be sent in for inspection.

Bar graph



Indicates the **strength of the received laser light**.
The center bar represents the **ATT** warning threshold. The distance value remains valid and is output at the interfaces.
If no bar graph is available, the **PLB** status information appears at the same time.
The measurement value is assessed as implausible. Depending on the configuration, either zero or the last valid measurement value is output at the interfaces.

Interface info

An activated DeviceNet interface is indicated by the presence of MAC ID (bus address) and the "DNET" ID in the display. If the DeviceNet interface is deactivated, the MAC ID and DNET ID are hidden from view.

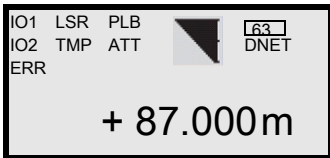

← MAC ID (bus address)
DNET identifier

← Position value

Position value

The measured position value is displayed in the configured unit of measurement.

+87.000m With the **metric** setting, the measurement value is always displayed in meters to **three decimal places**.

+87.0in With the **inch** setting, the measurement value is always displayed in inches to **one decimal place**.

8.2.2 LED status indicators

After power ON, the Power LED and Net LED are tested as follows:

1. LEDs off.
2. LEDs are switched to green for approx. 0.25s.
3. LEDs are switched to red for approx. 0.25s.
4. LEDs off.

This is followed by the status display for the Power LED (see chapter 9.3) and the Net LED.

PWR LED

PWR

**Off****Device OFF**

- No supply voltage

PWR

**Flashing green****Power LED flashes green**

- LED function test for 0.25s after power up
- No measurement value output
- Voltage connected
- Self test running
- Initialization running
- Parameter download running
- Boot process running

PWR

**Green continuous light****Power LED green**

- AMS 355*i*/OK
- Measurement value output
- Self test successfully finished
- Device monitoring active

PWR

**Red flashing****Power LED flashes red**

- LED function test for 0.25s after power up
- Device OK but warning message (ATT, TMP, LSR) set in display
- Light beam interruption
- Plausibility error (PLB)

PWR

**Red continuous light****Power LED red**

- No measurement value output; for details, see display

PWR

**Orange continuous light****Power LED orange**

- Parameter enable active
- No data on the host interface

NET LED



Off

NET LED off

- The DUP MAC ID test is active
- No voltage supply
- The V+/V- voltage supply for the DeviceNet data driver is missing



Green, flashing

NET LED flashes green

- LED function test for 0.25s after power up
- DUP MAC ID test ok but no connection to other addresses can be established
- AMS 355/i is not assigned to a master



Green, continuous light

NET LED green

- AMS 355/i bus communication ok



Red, flashing

NET LED flashes red

- LED function test for 0.25s after power up
- Time-out in bus communication



Red, continuous light

NET LED red

- No communication can be established



Green/red, flashing

NET LED flashes green/red

- The AMS 355/i has detected an identity communication error on the network. Protocol message too long.

8.2.3 Control buttons



Up

Navigate upward/sideways.



Down

Navigate downward/sideways.



ESC

Exit menu item.



ENTER

Confirm/enter value, change menu levels.

Navigating within the menus

The menus within a level are selected with the up/down buttons  .

The selected menu item is activated with the enter button .







Press the ESC button  to move up one menu level.

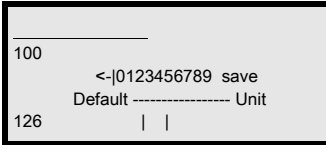



When one of the buttons is actuated, the display illumination is activated for 10 min.



Setting values

If input of a value is possible, the display looks like this:



-  +  Delete character
-  ...  +  Enter digit
- save +  Save



Use the   and  buttons to set the desired value. An accidental, incorrect entry can be corrected by selecting <-| and then pressing .

Then use the   buttons to select save and save the set value by pressing .

Selecting options

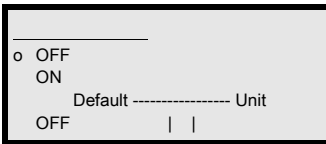
If options can be selected, the display looks like this:



Select the desired option with the   buttons. Activate the option by pressing .

8.3 Menu description

8.3.1 The main menus

After voltage has been applied to the laser, device information is displayed for several seconds. The display then shows the measurement window with all status information.

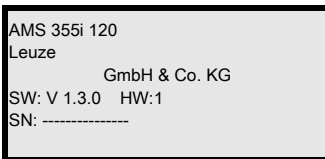

Device information - main menu

- This menu item contains detailed information on
- Device type
 - Manufacturer
 - Software and hardware version
 - Serial number
- No entries can be made via the display.

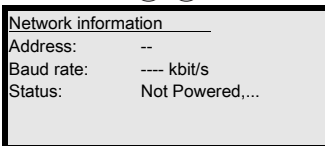

Network information - main menu

- Explanations of address, baud rate, status.
- No entries can be made via the display.

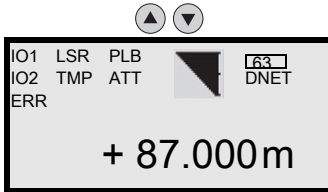

Status and measurement data - main menu

- Display of status, warning and error messages.
- Status overview of the switching inputs/outputs
- Bar graph for the received signal level.
- Link
- Measurement value

No entries can be made via the display. See "Indicators in the display" on page 40.

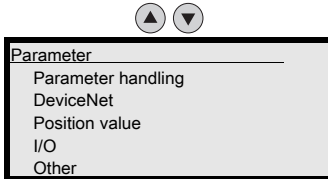

Parameter - main menu

- Configuration of the AMS.
- See "Parameter menu" on page 45.

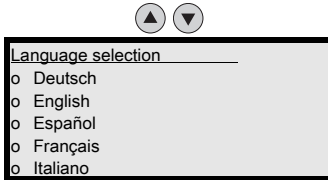

Language selection - main menu

- Selection of the display language.
- See "Language selection menu" on page 50.

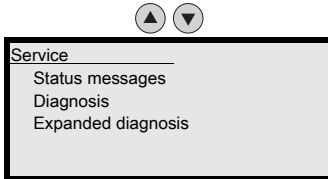

Service - main menu

- Display of status messages.
 - Display of diagnostic data.
- No entries can be made via the display. See "Service menu" on page 50.



Note!

*The rear cover of this manual includes a **fold-out page** with the complete **menu structure**. It describes the menu items in brief.*

8.3.2 Parameter menu

Parameter handling submenu

The following functions can be called up in the Parameter handling submenu:

- Lock and enable parameter entry
- Set up a password
- Reset the AMS 355*i* to the default settings

Table 8.1: Parameter handling submenu

Level 3	Level 4	Level 5	Selection/configuration option Description	Standard
Parameter enable			ON/OFF The standard setting (OFF) prevents unintended parameter changes. With parameter enable activated (ON), the display is inverted. In this state, it is possible to change parameters manually.	OFF
Password	Activate password		ON/OFF To enter a password, parameter enable must be activated. If a password is assigned, changes to the AMS 355i can only be made after the password is entered. The master password 2301 overrides the individually set password.	OFF
	Password entry		For setting a four-digit numerical password.	
Parameters to default			By pressing the enter button (↵) after selecting Parameters to default, all parameters are reset to their standard settings without any further security prompts. In this case, English is selected as the display language.	

Additional important information on parameter handling can be found at the end of the chapter.

DeviceNet submenu

Tabelle 8.2: DeviceNet submenu

Level 3	Level 4	Level 5	Selection/configuration option Description	Standard
Activation			ON/OFF	ON
Node ID			Entry of the device address.	63
Baud rate			125kbit/s / 250kbit/s / 500kbit/s Selection of the serial communication baud rate. The baud rate specifies the velocity of the data transmission. It must be identical on transmitter and receiver side in order to enable communication.	125kbit/s

Position value submenu



Note!

The parameters named under position value are to be set via the EDS file of the AMS 355i. If parameters from the Position value submenu are changed via the display, these are overwritten via the EDS file stored in the control with the values stored there.

Table 8.3: Position value submenu

Level 3	Level 4	Level 5	Selection/configuration option Description	Standard
Unit			Metric/Inch Specifies the units of the measured distances	Metric
Counting direction			Positive/Negative Positive: The measurement value begins at 0 and increases with increasing distance. Negative: The measurement value begins at 0 and decreases with increasing distance. Negative distance values may need to be compensated with an offset or preset.	Positive
Offset			Output value = measurement value + offset The resolution of the offset value is independent of the selected "Position resolution" and is entered in mm or inch/100. The offset value is effective immediately after entry. If the preset value is activated, this has priority over the offset. Pre-set and offset are not offset against each other.	0 mm
Preset			The preset value is accepted by means of teach pulse. The teach pulse can be applied to a hardware input of the M12 PWR connector. The hardware input must be appropriately configured. See also configuration of the I/Os.	0 mm
Free resolution value			The measurement value can be resolved in increments of 1/1000 within the 5 ... 50000 value range. If e.g. a resolution of 0.875mm per digit is required, the parameter is set to 875. Although the parameter can be set via the display, it is overwritten in any case by the values stored in the EDS file. I.e. it must be changed via the EDS file.	1000
Error delay			ON/OFF Specifies whether, in the event of an error, the position value immediately outputs the value of the "Position value in the case of failure" parameter or the last valid position value for the configured error delay time.	ON/100 ms
Position value in the case of failure			Last valid value / zero Specifies which position value is output after the error delay time elapses.	Zero

I/O submenu

Table 8.4: I/O submenu

Level 3	Level 4	Level 5	Selection/configuration option Description	Standard
I/O 1	Port configuration		Input/Output Defines whether I/O 1 functions as an output or input.	Output
	Switching input	Function	No function/teach preset/laser ON/OFF	No function
		Activation	Low active/High active	Low active
	Switching output	Function	Pos. limit value 1 / Pos. limit value 2 / Velocity / Intensity (ATT) / Temp. (TMP) / Laser (LSR) / Plausibility (PLB) / Hardware (ERR) The individual functions are "ORed" on the selected switching output.	Plausibility (PLB), hardware (ERR)

Table 8.4: I/O submenu

Level 3	Level 4	Level 5	Selection/configuration option Description	Standard
		Activa- tion	Low active/High active	Low active
I/O 2	Port con- figuration		Input/Output Defines whether I/O 2 functions as an output or input.	Output
	Switching input	Function	No function/teach preset/laser ON/OFF	No function
		Activa- tion	Low active/High active	Low active
	Switching output	Function	Pos. limit value 1 / Pos. limit value 2 / Velocity / Intensity (ATT) / Temp. (TMP) / Laser (LSR) / Plausibility (PLB) / Hardware (ERR) The individual functions are "ORed" on the selected switching output.	Intensity (ATT), Temp. (TMP), Laser (LSR)
		Activa- tion	Low active/High active	Low active
Limit values	Upper pos. limit 1	Activa- tion	ON/OFF	OFF
		Limit value input	Value input in mm or inch/100	0
	Lower pos. limit 1	Activa- tion	ON/OFF	OFF
		Limit value input	Value input in mm or inch/100	0
	Upper pos. limit 2	Activa- tion	ON/OFF	OFF
		Limit value input	Value input in mm or inch/100	0
	Lower pos. limit 2	Activa- tion	ON/OFF	OFF
		Limit value input	Value input in mm or inch/100	0

Other submenu

Table 8.5: Other submenu

Level 3	Level 4	Level 5	Selection/configuration option Description	Standard
Heating control			Standard (10°C ... 15°C)/Extended (30°C ... 35°) Defines a switch-on/switch-off range for the heating control. The extended switch-on/switch-off range for heating may provide a remedy in the event of condensation problems. Due to the limited heating capacity, it cannot be guaranteed that no condensation will form on the optics in the extended switch-on/switch-off range. This parameter is available as standard, but functions only for devices with integrated heating (AMS 355 <i>i</i> ... H).	Standard
Display illumination			10 minutes/ON Display illumination is switched off after 10 minutes or, if the parameter is set to "ON", illumination is always on.	10 min
Display contrast			Weak/Medium/Strong The display contrast may change at extreme temperature values. The contrast can subsequently be adapted using the three levels.	Medium
Service RS232	Baud rate		57.6kbit/s / 115.2kbit/s The service interface is only available to Leuze personnel.	115.2kbit/s
	Format		8,e,1 / 8,n,1 The service interface is only available to Leuze personnel.	8,n,1

8.3.3 Language selection menu

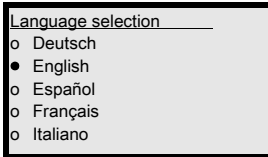

5 display languages are available:

- German
- English
- Spanish
- French
- Italian

The AMS 355*i* is delivered from the factory with the display preset to English.



Note!

*When operating the AMS 355*i* on the DeviceNet, the language configured in the EDS file is used in the display.*

To change the language, no password needs to be entered nor must parameter enable be active. The display language is a passive operational control and is therefore not a function parameter per se.

8.3.4 Service menu

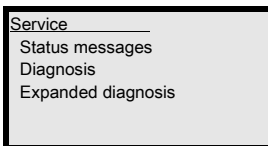

A detailed description of the individual functions can be found in Chapter 10.

8.4 Operation

An operating process is described here using parameter enable as an example.

Parameter enable

During normal operation parameters can be viewed only. If parameters are to be changed, the ON menu item in the Parameter -> Parameter handling -> Parameter enable menu must be activated. To do this, proceed as follows.

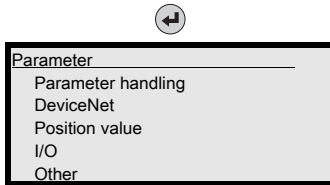

In the main menu, press the enter button to enter the Parameter menu.

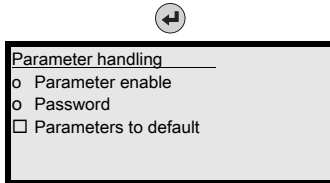

Use the ▲▼ buttons to select the Parameter handling menu item.

Press the enter button to enter the Parameter handling menu.

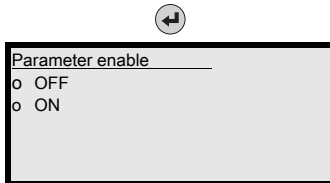

In the Parameter handling menu, use the ▲▼ buttons to select the Parameter enable menu item.

Press the enter button to enter the Parameter enable menu.



In the Parameter enable menu, use the ▲▼ buttons to select the ON menu item.

Press the enter button to activate parameter enable.

The PWR LED lights up orange; the display is inverted. You can now set the individual parameters on the display.



Press the ESC button twice to return to the Parameter menu.



Viewing and editing parameters

As long as parameter enable is active, the entire AMS 355i display is inverted.

As long as parameter enable is active, communication between control and AMS 355i is interrupted. The extended networking via BUS OUT is retained.



Attention!

The Rockwell control offers the possibility of activating the Configuration Recovery function.

According to the criteria specified by Rockwell Automation, Configuration Recovery automatically downloads parameters to the AMS 355*i*. This results in parameters that were manually changed via the display being restored by the control to the configured AMS 355*i* data from the EDS file. The parameters that were manually changed via the display are, thus, no longer valid.

The address setting made on the AMS 355*i* for DeviceNet (MAC ID) is not affected by automatic changes.

**Attention!**

If the **Configuration Recovery** function is not activated, parameters set manually via the display are activated the moment parameter enabling is again deactivated on the AMS 355*i*.

**Note!**

If a password was stored, parameter enable is not possible until this password is entered; see "Password for parameter enable" below.

Password for parameter enable

Parameter entry on the AMS 355*i* can be protected with a password. With the AMS 355*i*, the password is defined via the EDS file (class 100, instance 1). Therefore, the password cannot be changed by means of display entry.

To activate parameter enable via the display (e.g. for changing an address), the password defined in the EDS file must be entered. If parameter enable has been activated after successfully entering the password, parameters can be temporarily changed via the display.

After parameter enable is deactivated, all changes made on the display are overwritten by the ESD file (see above). If a new password has been assigned, this, too, is overwritten by the password defined in the EDS file.

**Note!**

The **master password 2301** can enable the AMS 355*i* at any time.

9 DeviceNet interface

9.1 General information on DeviceNet

9.1.1 Topology

A bus address is assigned to each participant connected to DeviceNet; this address is represented by a DeviceNet **MAC ID (Media access control identifier)**.

Including the master, up to 64 participants can be connected to one network. The address range spans from 0 to 63.

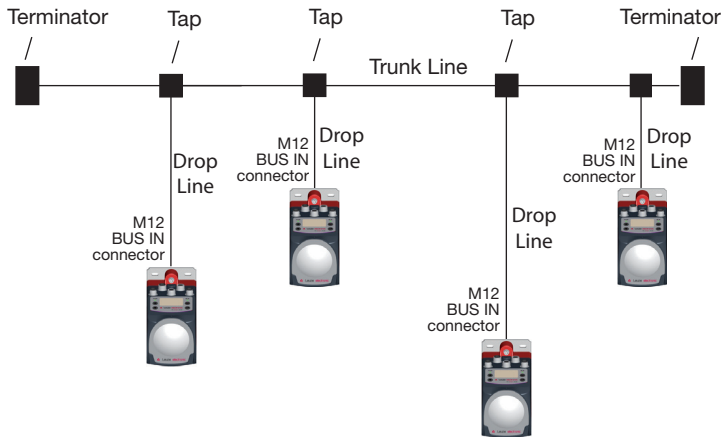

Figure 9.1: Bus topology



Attention!

According to DeviceNet specification (Volume 3: DeviceNet Adaptation of CIP Chapter 8, Physical Layer 8-3.3 Connectors), use of the BUS OUT connection is not allowed.

The topologies presented here are enabled according to the directives of the ODVA.

On the respective ends of the trunk line (master line), the bus must be terminated with a 120 ohm terminating resistor. A cable specified by the ODVA is required for connecting the participants to DeviceNet.

In addition to the two signals for data transmission – CAN_L and CAN_H – the DeviceNet cable also provides two additional lines for supplying the network device or bus transceiver with power.

**Note!**

In accordance with the ODVA specification, on the AMS 355*i* the bus transceivers are supplied via the V+/V- lines provided in the data line. Without this voltage supply, the device cannot operate.

Only cables that satisfy the ODVA specifications may be used.

The limits of network expansion without repeater are specified by the ODVA. The specified limit values are dependent on the design of the data line.

A distinction is made between "thick cable", "mid cable" and "thin cable".

DeviceNet installation

Up to 64 network devices can communicate with one another in a DeviceNet network with baud rates of 125, 250 or 500 kBaud. In addition to the two signals for data transmission – CAN-L and CAN-H – the DeviceNet cable also includes two cables for supplying the DeviceNet bus transceiver with 11 ... 25VDC. Without this V+/V- supply fed to the bus transceiver via the data cable, the AMS 355*i* cannot operate. The maximum length of the DeviceNet cable is dependent on the selected cable type and baud rate. Installation is performed in bus topologies like that shown in the figure above, and with terminating resistors at both ends.

Listed in the table are the max. network expansions as a function of the used data line without repeater.

	Transmission rate								
	125 kbit/s			250 kbit/s			500 kbit/s		
Cable type	1 ¹⁾	2 ²⁾	3 ³⁾	1	2	3	1	2	3
Max. length of master line (trunk line) in m	500	300	100	250			100		
Max. length of stub cable (drop line) in m	6			6			6		
Max. length of all stub cables per network in m	156			78			39		

1) Thick cable = 1

2) Mid cable = 2

3) Thin cable = 3

The ready-made data lines from Leuze correspond to the thin cable.

9.1.2 Communication

EDS files (Electronic Data Sheet) are used for all CIP-based protocols. For the AMS 35xi product series, these are the following protocols:

- EtherNet/IP
- DeviceNet

You can find the EDS file at www.leuze.com

The EDS file contains all communication parameters of the participants, as well as the available objects. The DeviceNet communication tool reads the EDS files of the participants present in the network and uses this information to calculate the configuration data that is subsequently loaded onto the participants.

The input/output data is addressed according to the following fundamental scheme:

1. Device address (MAC ID)
The participant is addressed with its MAC ID, which is unique in the network.
2. Object class identifier (class)
Used as the basis for addressing the desired object class.
3. Object instance identifier (instance)
Addressing of the object instance within the object class.
4. Attribute identifier (attribute)
Addressing of the attribute within the object instance.
5. Service code (get, set, reset, start, stop and others...)
The service code ultimately describes the type of access to the data, e.g., reading or writing.

9.2 DeviceNet electrical connection



BUS IN (5-pin connector, A-coded)		
Pin	Name	Comment
1	Drain	Shield
2	V+	Data V+ supply voltage
3	V-	Data V- supply voltage
4	CAN_H	Data signal CAN_H
5	CAN_L	Data signal CAN_L
Thread	FE	Functional earth (housing)

BUS OUT (5-pin socket, A-coded)		
Pin	Name	Comment
1	Drain	Shield
2	V+	Data V+ supply voltage
3	V-	Data V- supply voltage
4	CAN_H	Data signal CAN_H
5	CAN_L	Data signal CAN_L
Thread	FE	Functional earth (housing)

Figure 9.1: DeviceNet - Electrical connection

- 1) According to DeviceNet specification (Volume 3: DeviceNet Adaptation of CIP Chapter 8, Physical Layer 8-3.3 Connectors), use of the BUS OUT connection is not allowed.



Note!

In its specification (*DeviceNet Adaptation of CIP, Chapter 8, Physical Layer, 8-3-3 Connectors*), the ODVA recommends connecting the AMS 355i via taps on drop lines (see figure 9.1). In this topology suggested by the ODVA, the BUS OUT connection remains unused. If the AMS 355i is disconnected, the remaining participants in the network can continue to be addressed.

As before, the BUS OUT connection constitutes a full-featured connection for a further network device. If, however, the AMS 355i is disconnected from the bus, all participants connected to BUS OUT can then also no longer be addressed. For this reason, the ODVA recommends that these topologies not be used.

9.3 Electrical data for Data V+ and Data V- supply voltage

Data V+ supply voltage	11 ... 25VDC
Data V- supply voltage	Reference potential
Current consumption of AMS 355 <i>i</i> at Data V+	max. 80mA at 11VDC



Note!

*In accordance with the ODVA specification, on the AMS 355*i* the bus transceivers are supplied via the V+/V- lines provided in the data line. Without this voltage supply, the device cannot operate.*

Only cables that satisfy the ODVA specifications may be used.



Attention!

*The preassembled data lines for DeviceNet have a maximum load of 1.4A for supplying the bus transceivers. The current consumption of the AMS 355*i* at the supply lines for the bus transceiver is max. 80mA at 11VDC.*

When networking the bus data line to other participants via BUS OUT, please note that the maximum load of 1.4A must not be exceeded. Ensure a reliable power supply by providing an appropriate power supply unit.



Note!

*For connecting **BUS IN** and **BUS OUT**, we recommend our ready-made DeviceNet cables (see chapter 11.4.6 "Accessories - Ready-made cables for DeviceNet").*

9.4 DeviceNet address entry - MAC ID



Note!

Basic operation of the display is described in Chapter 8.2. To set the DeviceNet MAC ID, parameter enable must be activated. After the parameters are enabled, the display is inverted.



Attention!

The laser measurement system is deactivated on the DeviceNet when parameter enable is activated via the display. The device is reactivated on the DeviceNet after parameter enable is canceled.

9.4.1 Entering the MAC ID (address) via the display

To do this proceed as follows:

- ↳ *Activate Parameter enable.*
- ↳ *Select the DeviceNet submenu.*
- ↳ *Select the menu item DeviceNet MAC ID (address).*
- ↳ *Enter a DeviceNet MAC ID between 0 and 63 (default: 63).*
- ↳ *Save the DeviceNet MAC ID with save.*

↪ *Deactivate parameter enable.*

9.5 EDS file - general info

An EDS file (Electronic Data Sheet) is provided for the AMS 355*i*.

The EDS file is named "AMS355i.eds"; the corresponding icon is named "AMS355i.ico"

Both files can be downloaded at the Leuze homepage www.leuze.com.

The EDS file contains all identification and communication parameters of the device, as well as the available objects.

The AMS 355*i* is uniquely classified via a class 1 identity object (component of the AMS355i.eds file) for the DeviceNet scanner (master).

The identity object contains, among other things, a manufacturer-specific Vendor ID, as well as an ID that describes the principle function of the participant.

The AMS 355*i* has the following identity object (class 1):

Vendor ID: 524_{Dec} / 20C_H

Device type: 34_{Dec} / 22_H (identifies the AMS 355*i* as an "encoder")

Position sensor type: 8_{Dec} / 8_H (specifies the AMS 355*i* as an "absolute encoder")

The types of communication access to the data of the AMS 355*i* described by the ODVA:

- Polling
- Cyclic
- Combinations of polling and cyclic

are supported by the AMS 355*i*.



Attention!

*Communication access via **change of state** is not implemented and must not be activated in the network configuration.*

If accepting the objects without change, all parameters are set to default values. The default settings are shown in the objects described in detail in the "Default" column.

An assembly is activated by default in the EDS file. The assembly automatically communicates its inputs and outputs to the control. Further information on the assemblies can be found in Chapter 9.6.5 and Chapter 9.6.1.



Attention!

*The Rockwell control offers the possibility of activating the **Configuration Recovery** function. This stores the parameters defined in the EDS file in the control. If necessary, an automatic parameter download from the control to the AMS 355*i* takes place.*

Leuze recommends activating "Configuration Recovery". This stores all parameters in the control.

The automatically performed parameter download (Configuration Recovery activated) causes a parameter change to be reversed immediately after deactivation of parameter enable in the AMS 355*i*.



Attention!

If the "Configuration Recovery" function is **not activated**, the parameters changed via the display apply. The parameters are **not overwritten automatically**.

As before, it is possible to manually download the parameters stored in the control.



Note!

In the following tables, all attributes marked in the "Access" column with "Get" in the individual objects are to be understood as inputs of the scanner (control). E.g. "Read in the position value" --> Class 35; instance 1; attribute 10.

Attributes marked in the "Access" column with "Set" represent outputs or parameters. Outputs are set, e.g. "Laser off"--> Class 35; instance 1; attribute 110.

Parameters are also marked with "Set" and written to the AMS. E.g. "Change the position format" --> Class 35; instance 1; attribute 15.

9.6 EDS file - detailed description

9.6.1 Class 4 Assembly

9.6.1.1 Position value

Cl.	Path		Designation	Size in bit	Data type	Default (dec)	Min. (dec)	Max. (dec)	Access
	Inst.	Attr.							
4	1	3	Position	32	DINT	0	-2147483648	+2147483648	Get

Instance 1, attribute 3

Input assembly: length 4 bytes

Assembly to read out the position value. According to the definition from the ODVA, the assembly with instance 1 is a mandatory assembly in the encoder profile. This assembly is configured in Class 101 by default

Inst.	Byte	Bit 7	Bit 6	Bit 5	Bit 4	Bit 3	Bit 2	Bit 1	Bit 0
1	0	Position value (low byte)							
	1	Position value							
	2	Position value							
	3	Position value (high byte)							



Note!

Negative values are shown in two's complement.

9.6.1.2 Position value + status

Cl.	Path		Designation	Size in bit	Data type	Default (dec)	Min. (dec)	Max. (dec)	Access
	Inst.	Attr.							
4	100	3	Position value	32	DINT	-	-21474836480	+2147483648	Get
			Status	8	Byte	-	0	31	Get
			Alarm warning	8	Byte	-	0	31	Get

Instance 100, attribute 3

Input assembly: length 6 bytes

Leuze-specific assembly

Byte 0 - Byte 3: position value

Byte 4: AMS 355/status

Byte 5: AMS 355/alarms and warnings

Inst.	Byte	Bit 7	Bit 6	Bit 5	Bit 4	Bit 3	Bit 2	Bit 1	Bit 0
100	0	Position value (low byte)							

Inst.	Byte	Bit 7	Bit 6	Bit 5	Bit 4	Bit 3	Bit 2	Bit 1	Bit 0
	1	Position value							
	2	Position value							
	3	Position value (high byte)							
	4	0	0	0	Preset toggle	Preset status 1 = ON 0 = OFF	I/O state 2 1 = ON 0 = OFF	I/O state 1 1 = ON 0 = OFF	Laser diode ON / OFF 1 = ON 0 = OFF
	5	0	0	0	ATT 1 = ON 0 = OFF	LSR 1 = ON 0 = OFF	TMP 1 = ON 0 = OFF	PLB 1 = ON 0 = OFF	ERR 1 = ON 0 = OFF



Note!
Negative values are shown in two's complement.

9.6.1.3 Velocity value + state

Cl.	Path		Designation	Size in bit	Data type	Default (dec)	Min. (dec)	Max. (dec)	Access
	Inst.	Attr.							
4	101	3	Velocity value	32	DINT	-	-999,999	+999,999	Get
			Status	8	Byte	-	0	63	Get
			Alarm warning	8	Byte	-	0	31	Get

Instance 101, attribute 3

Input assembly: length 6 bytes

Leuze-specific assembly

- Byte 0 - Byte 3: velocity value
- Byte 4: AMS 355/velocity status
- Byte 5: AMS 355/alarms and warnings

Inst.	Byte	Bit 7	Bit 6	Bit 5	Bit 4	Bit 3	Bit 2	Bit 1	Bit 0
100	0	Velocity value (low byte)							
	1	Velocity value							
	2	Velocity value							
	3	Velocity value (high byte)							
	4	0	0	Direction of movement 0 = Pos. 1 = Neg.	Movement status 1 = Mov. 0 = No mov.	Limit value 4 1 = ON 0 = OFF	Limit value 3 1 = ON 0 = OFF	Limit value 2 1 = ON 0 = OFF	Limit value 1 1 = ON / OFF 0 = OFF
	5	0	0	0	ATT 1 = ON 0 = OFF	LSR 1 = ON 0 = OFF	TMP 1 = ON 0 = OFF	PLB 1 = ON 0 = OFF	ERR 1 = ON 0 = OFF



Note!
Negative values are shown in two's complement.

9.6.1.4 Preset value + control

Cl.	Path		Designation	Size in bit	Data type	Default (dec)	Min. (dec)	Max. (dec)	Access
	Inst.	Attr.							
4	120	3	Preset value	32	DINT	-	-21474836480	+2147483648	Set
			Preset control	8	Byte	-	0	3	Set

Instance 120, attribute 3

Output assembly: length 5 bytes

Leuze-specific assembly

Byte 0 - Byte 3: preset value

Byte 4: preset control

Inst.	Byte	Bit 7	Bit 6	Bit 5	Bit 4	Bit 3	Bit 2	Bit 1	Bit 0
120	0	Preset value (low byte)							
	1	Preset value							
	2	Preset value							
	3	Preset value (high byte)							
	4	0	0	0	0	0	0	0	Preset reset 1 = ON 0 = OFF



Note!

Negative values are shown in two's complement.

9.6.2 Class 1 Identity object

Object class 1 = 01_H

Services:

- Get Attribute Single
- Reset type 0

Cl.	Path		Designation	Size in bit	Data type	Default (dec)	Min. (dec)	Max. (dec)	Access
	Inst.	Attr.							
1	1	1	Vendor ID	16	UINT	524	-	-	Get
		2	Device type	16	UINT	34	-		Get
		3	Product Code	16	UINT	1002	-		Get
		4	Revision (Major, Minor)	16	Struct{ USINT major, USINT minor};	Major = 1, Minor = 1	Major = 1, Minor = 1	Major = 127, Minor = 999	Get
		5	Status	16	WORD	See CIP specification (5-2.2.1.5 status)			Get
		6	Serial Number	32	UDINT	Manufacturer specific			Get
		7	Product Name	(max. 32) x 8	SHORT_STRING	"AMS 355i"			Get

In the network configuration (e.g., RS Networkx), it is possible to specify when entering the individual participants in the scan list which attributes of the scanner are to be monitored from the identity object.

The selection is made in the "Electronic key" field. Attributes marked there are monitored.

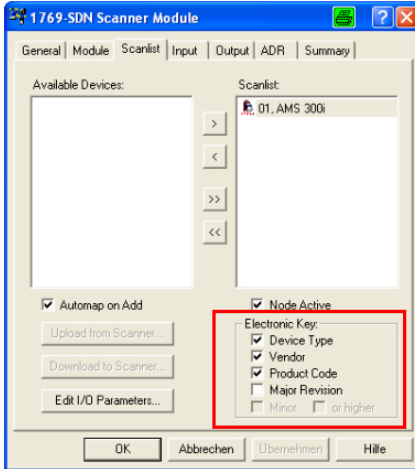

In the event of a device exchange, the major revision number should **not** be monitored. The major revision number describes the firmware version of the AMS 355*i* software within the EDS file/object 1. This may have changed during a possible device exchange. The scanner would otherwise output an error message after a device is changed.

9.6.2.1 Vendor ID

The Vendor ID assigned by ODVA for Leuze electronic GmbH + Co. KG is 524_D.

9.6.2.2 Device type

The AMS 355*i* is defined by Leuze as an encoder. According to ODVA, the AMS 355*i* is assigned number 34_D = 22_H.

9.6.2.3 Product Code

The product code is an ID assigned by Leuze that has no further impact on other objects.

9.6.2.4 Revision

Version number of the identity object.

9.6.2.5 Status

Basic and higher-level monitoring of the device, network and configuration. The entries are described by the scanner.

Bit 7	Bit 6	Bit 5	Bit 4	Bit 3	Bit 2	Bit 1	Bit 0
Ext. device state				Reserved	Configured	Reserved	Owned
Bit 15	Bit 14	Bit 13	Bit 12	Bit 11	Bit 10	Bit 9	Bit 8
Reserved				Major unrecoverable fault	Major recoverable fault	Major unrecoverable fault	Major recoverable fault

9.6.2.6 Serial number

For use in DeviceNet, the serial number receives a serial number converted according to CIP. CIP describes a special format for the serial number. After conversion to a CIP code, the serial number is, as before, unique, but no longer corresponds in its resolution to the serial number on the name plate.

9.6.2.7 Product Name

This attribute contains a short designation of the product. Devices with the same product code may have different "product names".

9.6.3 Class 35 Position sensor object

Object class 35 = 23_H

Services:

- Get Attribute Single
- Set Attribute Single

Cl.	Path		Designation	Size in bit	Data type	Default (dec)	Min. (dec)	Max. (dec)	Access
	Inst.	Attr.							
35	1	10	Position value	32	DINT	0	-2147483648	2147483647	Get
		11	Sensor type	16	UINT	8	-	-	Get
		12	Direction Counting	8	BYTE	0	0	1	Set
		15	Position format	16	ENGUNIT	8707	See below		Set
		24	Velocity value	32	DINT	0	-999,999	999,999	Get
		25	Velocity format	16	ENGUNIT	2064	See below		Set
		26	Velocity resolution	32	UDINT	1000	1	50,000	Set
		41	Operating status	8	BYTE	0	See below		Get
		44	Alarms	16	WORD	0	See below		Get
		45	Supported alarms	16	WORD	See below			Get
		46	Alarm flag	8	BYTE	0	0	1	Get
		47	Warnings	16	WORD	0	See below		Get
		48	Supported warnings	16	WORD	See below			Get
		49	Warning flag	8	BYTE	0	0	1	Get
		50	Operating time	32	UDINT	0	0	4294967295	Get
		100	Preset value	32	DINT	0	-999,999	999,999	Set
		101	Preset teach	8	BYTE	0	0	1	Set
		102	Preset status	8	BYTE	0	0	1	Get
		103	Preset toggle	8	BYTE	0	0	1	Get
		104	Preset reset	8	BYTE	0	0	1	Set
		105	Direction of movement	8	BYTE	0	0	1	Get
		106	Movement status	8	BYTE	0	0	1	Get
		107	Free resolution	16	UINT	5	5	50,000	Set
		108	Offset value	32	DINT	0	-999,999	999,999	Set
		109	Laser status	8	BYTE	0	0	1	Get
		110	Laser control	8	BYTE	0	0	1	Set

In the CIP network specifications, the function of object class 35 (23_H) is defined as a "position sensor object". The position sensor object describes the functions of an absolute measuring encoder. As defined in the CIP specification, the attributes with address 1 to 99 are functionally predetermined. From this address range, the AMS 355*i* uses only attributes that are functionally mapped in the AMS. The address range ≥ 100 is manufacturer-specific.

9.6.3.1 Position Value

Attribute 10

Reading out position value.

Attr.	Byte	Bit 7	Bit 6	Bit 5	Bit 4	Bit 3	Bit 2	Bit 1	Bit 0
10	0	Position value (low byte)							
	1	Position value							
	2	Position value							
	3	Position value (high byte)							

**Note!**

Negative values are shown in two's complement.

9.6.3.2 Position sensor type

Attribute 11

Specifies the encoder with the CIP-defined identifier 8_a as an absolute measuring linear encoder.

9.6.3.3 Direction Counting

Attribute 12

Defines whether the measured distance value increases as the distance increases (positive counting direction) or as the distance decreases (negative counting direction).

0 = Positive counting direction

1 = Negative counting direction

9.6.3.4 Position format

Attribute 15

Configures the position format as well as the resolution. The EDS file provides the following parameters:

Dec. value	Hex. Value	Unit	Format
8706	0x22 02	Centimeter [cm]	metric
8707	0x22 03	Millimeter [mm]	
8708	0x22 04	Micrometer [μ m]	
2048	0x08 00	Free resolution [mm]	
2049	0x08 01	Tenth of millimeter [mm/10]	
2050	0x08 02	Hundredth of millimeter [mm/100]	
2051	0x08 03	Hundredth of inch [in/100]	Inch
2052	0x08 04	Free resolution [in/100]	

**Note!**

If the position format is changed from metric to inch, the velocity format is internally changed automatically to hundredths of inch per second. If the position format is changed from inch to metric, the velocity format is internally changed automatically to millimeters per second.

9.6.3.5 Velocity value

Attribute 24

Reading out velocity value.

Attr.	Byte	Bit 7	Bit 6	Bit 5	Bit 4	Bit 3	Bit 2	Bit 1	Bit 0
24	0	Velocity value (low byte)							
	1	Velocity value							
	2	Velocity value							
	3	Velocity value (high byte)							



Note!

Negative values are shown in two's complement.

9.6.3.6 Velocity format

Attribute 25

Configures the velocity format as well as the resolution. The EDS file provides the following parameters:

Dec. value	Hex. Value	Unit	Format
11008	0x2B 00	Meter per second [m/s]	metric
11009	0x2B 01	Centimeter per second [cm/s]	
2064	0x08 10	Millimeter per second [mm/s]	
2065	0x08 11	Decimeter per second [dm/s]	
2066	0x08 12	Hundredth of inch per second [in/100s]	Inch
2067	0x08 13	Meter per minute [m/min]	metric
2068	0x08 14	Free resolution [mm/100s]	
2069	0x08 15	Free resolution [in/1000s]	Inch



Note!

The velocity format "hundredth of inch per second [in/100s] and free resolution [in/1000s]" can be selected only if either hundredth of inch [in/100] or free resolution [in/100] has been selected in attribute 15 (Position format).

9.6.3.7 Velocity free resolution

Attribute 26

The free resolution refers to parameters 2068 and 2069 in attribute 25 (Velocity format). The entry is made in mm/100 s for parameter 2068 and in inch/1000 s for parameter 2069.

9.6.3.8 Operating status - Direction counting

Attribute 41

Bit 7	Bit 6	Bit 5	Bit 4	Bit 3	Bit 2	Bit 1	Bit 0
Vendor spec.			Reserved			Scaling	Direction

Attribute 41 is the response of the AMS 355*i* to the counting direction configured in attribute 12.

The counting direction is output in bit 0.

- 0 = Positive counting direction
- 1 = Negative counting direction

Bits 1 to 7 are irrelevant and have the status 0.

9.6.3.9 Alarms

Attribute 44

Bit 7	Bit 6	Bit 5	Bit 4	Bit 3	Bit 2	Bit 1	Bit 0
Reserved						ERR	PLB
Bit 15	Bit 14	Bit 13	Bit 12	Bit 11	Bit 10	Bit 9	Bit 8
Vendor spec.				Reserved			

The PLB and ERR status messages generated by the AMS 355*/a* are entered in bit 0 and bit 1. The alarms entered here lead to incorrect measurement values at the AMS 355*/i*. The CIP specification makes a distinction between alarms and warnings.

The following applies for PLB and ERR:

- 0 = No alarm
- 1 = Alarm

9.6.3.10 Supported alarm

Attribute 45

Attribute 45 indicates which alarms specified by the position sensor object are supported by the AMS 355*/i*.

Bit 7	Bit 6	Bit 5	Bit 4	Bit 3	Bit 2	Bit 1	Bit 0
Reserved						1	1
Bit 15	Bit 14	Bit 13	Bit 12	Bit 11	Bit 10	Bit 9	Bit 8
Vendor spec.				Reserved			

Bit 0 = 1; PLB alarm is supported by the AMS 355*/i*.

Bit 1 = 1; ERR alarm is supported by the AMS 355*/i*.

Bit 2 to bit 15 = 0

9.6.3.11 Alarm flag

Attribute 46

The attribute evaluates the alarms supported in attribute 45, in an OR function (collective alarm).

9.6.3.12 Warnings

Attribute 47

According to the CIP specification, warning messages are messages that signal exceedance of internal limit values, but do not lead to incorrect measurement values.

As warnings, the AMS 355*i* enters the ATT, LSR and TMP status messages. A range for device-specific data is reserved for this purpose in the CIP specification (bits 13 to 15).

Bit 7	Bit 6	Bit 5	Bit 4	Bit 3	Bit 2	Bit 1	Bit 0
–	–	–	–	–	–	–	–
Bit 15	Bit 14	Bit 13	Bit 12	Bit 11	Bit 10	Bit 9	Bit 8
ATT	LSR	TMP	–	–	–	–	–

9.6.3.13 Supported warnings

Attribute 48

Attribute 48 indicates which warnings specified by the position sensor object are supported by the AMS 355*i*.

Bit 7	Bit 6	Bit 5	Bit 4	Bit 3	Bit 2	Bit 1	Bit 0
–	–	–	–	–	–	–	–
Bit 15	Bit 14	Bit 13	Bit 12	Bit 11	Bit 10	Bit 9	Bit 8
1	1	1	–	–	–	–	–

Bit 13 = 1; TMP warning is supported by the AMS 355*i*.

Bit 14 = 1; LSR warning is supported by the AMS 355*i*.

Bit 15 = 1; ATT warning is supported by the AMS 355*i*.

Bit 0 to bit 12 = 0

9.6.3.14 Warning flag

Attribute 49

The attribute evaluates the warnings supported in attribute 48, in an OR function (collective warning).

9.6.3.15 Operating time

Attribute 50

The value is incremented in 1/10 hours for as long as the AMS 355*i* is connected to voltage. The value cannot be reset.

9.6.3.16 Preset value

Attribute 100

The attribute enables the current position value to be set to a desired position value.

9.6.3.17 Preset teach

Attribute 101

The attribute activates the value configured in attribute 100.



Note!

As a result

- attribute 103 is toggled,

- attribute 102 is set.

9.6.3.18 Preset status

Attribute 102

The attribute indicates whether the preset function is activated.

1 = Preset active

0 = Preset inactive

9.6.3.19 Preset toggle

Attribute 103

The attribute is toggled after activation of the preset value.



Note!

Activation of the preset value via attribute 101.

9.6.3.20 Preset reset

Attribute 104

The attribute deletes the set preset value. The preset status (attribute 102) is set to inactive.

1 = Delete preset value.



Note!

Attribute 103 is toggled.

9.6.3.21 Direction of movement

Attribute 105

At a velocity > 100mm/s, the attribute indicates the direction of movement.

0 = Positive direction of movement

1 = Negative direction of movement

Definition of the direction of movement depends on class 35, instance 1, attribute 12:

- Counting direction positive:
Measurement values **increase** when the reflector moves away from the AMS 355/. In this case, the positive direction of movement is 0 in attribute 105.
- Counting direction negative:
Measurement values **decrease** when the reflector moves away from the AMS 355/. In this case, the positive direction of movement is 1 in attribute 105.

9.6.3.22 Movement status

Attribute 106

The attribute indicates whether, based on the value, a movement > 100mm/s is registered.

0 = |curr. velocity| < 100mm/s

1 = |curr. velocity| > 100mm/s

9.6.3.23 Free resolution

Attribute 107

The free resolution refers to parameters 2048 and 2052 in attribute 15.

The entry is made in mm/1000 for parameter 2048 and in inch/100,000 for parameter 2052.

Example:

For a free resolution of e.g. 0.875mm, the value "875" must then be entered for parameter 2048.

9.6.3.24 Offset

Attribute 108

Measurement value at the interface = measured distance + offset.

9.6.3.25 Laser diode status

Attribute 109

The attribute signals the status of the laser diode.

0 = Laser diode ON

1 = Laser diode OFF

9.6.3.26 Laser diode control

Attribute 110

This attribute is used to switch the laser on and off.

1 = Laser diode ON

0 = Laser diode OFF

9.6.4 Class 100 Display configuration

Object class 100 = 64_H

Services:

- Get Attribute Single
- Set Attribute Single

100	Path		Designation	Size in bit	Data type	Default (dec)	Min. (dec)	Max. (dec)	Access
	Cl.	Inst.							
	1	1	Language selection	8	BYTE	0	0	16	Set
		2	Password protection	8	BYTE	0	0	1	Set
		3	Password	16	UINT	0	0	9,999	Set
		4	Illumination	8	BYTE	0	0	1	Set
		5	Contrast	8	BYTE	1	0	3	Set
		6	Extended heating control	8	BYTE	0	0	1	Set

9.6.4.1 Language selection

Attribute 1

The attribute is used to configure the display language.

The table below provides information on the languages available.

Language	Value
English	0
German	1
Italian	2
Spanish	3
French	4

9.6.4.2 Password protection

Attribute 2

The attribute activates password protection.

1 = Password protection active

0 = Password protection not active

9.6.4.3 Password

Attribute 3

The attribute specifies the password. The password protection attribute (attribute 2) must be activated. Value range for the password: 0000 - 9999.

The master password **2301** is used to activate parameter enable via the display/panel.

9.6.4.4 Illumination

This attribute is used to set whether the display illumination is to be switched off 10 minutes after a button was last pressed, or whether the display illumination is always on.

0 = Display illumination switches off 10 minutes after a button was last pressed

1 = Display illumination is always on

9.6.4.5 Contrast

The display contrast can change under extreme ambient temperatures. This attribute adjusts the display illumination.

Value	Contrast
0	Weak
1	Medium
2	Strong

9.6.4.6 Extended heating control

This attribute is used to activate extended heating control.

The extended heating control range of the internal device heating can help to prevent condensation from forming on the optics of the AMS 358/. If the parameter is set, the internal heating of the AMS 358/ is switched on at high ambient temperatures (30°C).

In the case of extremely large and rapid changes in temperature and air humidity, the capacity of the internal heating may not be sufficient to prevent the formation of condensation.

	On	Off
0 = Switch-on/switch-off temperature for the internal heating:	10°C (50°F)	15°C (59°F)
1 = Switch-on/switch-off temperature for the internal heating:	30°C (86°F)	35°C (95°F)

9.6.5 Class 101 Assembly selection

Services:

- Get Attribute Single
- Set Attribute Single

Cl.	Path		Designation	Size in bit	Data type	Default (dec)	Min. (dec)	Max. (dec)	Access
	Inst.	Attr.							
101	1	1	Input assembly ID	8	BYTE	1	See below		Set
		2	Output assembly ID	8	BYTE	120	See below		

9.6.5.1 Input assembly

Attribute 1

The attribute provides an assembly for inputs. The EDS parameter "Input assembly" is used to select an assembly that **automatically** reads out data of the AMS 355/ with high priority after an arbitration cycle defined in the DeviceNet scanner.

Leuze has compiled additional input assemblies containing the most important data of the AMS 355/.

Customers cannot create their own assemblies because they are part of the EDS file supplied by Leuze.

A detailed description of the assemblies offered by Leuze can be found from Chapter 9.6.1.

9.6.5.2 Output assembly

Attribute 2

The attribute provides an assembly for outputs. The EDS parameter "Output assembly" is used to select an assembly which – after an arbitration cycle defined in the DeviceNet scanner – automatically writes data to the AMS 355/ with high priority.

Customers cannot create their own assemblies because they are part of the EDS file supplied by Leuze.

A detailed description of the assemblies offered by Leuze can be found from Chapter 9.6.1.4.



Attention!

During project planning with RS Network, Rockwell Automation requires configuration of the storage area for the assemblies selected in object class 101. If the assemblies in object class 101 are changed, the storage area in the scanner for assemblies must be adapted.

This is illustrated in the following screenshot from the RS Networkx configuration tool:

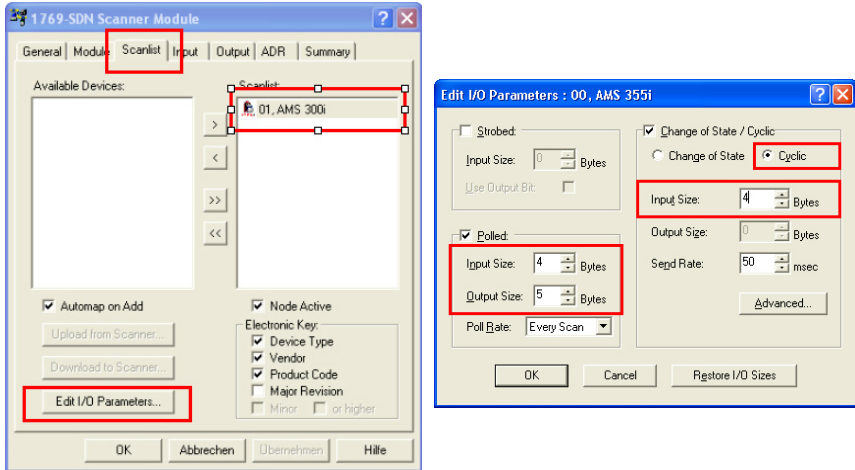

9.6.6 Class 103 Switching inputs / outputs

Class 103, instance 1 describes I/O 1 (PIN 2/M12 Power)

Class 103, instance 2 describes I/O 2 (PIN 4/M12 Power)

Object class 103 = 67_H

Services:

- Get Attribute Single
- Set Attribute Single

Cl.	Path		Designation	Size in bit	Data type	Default (dec)	Min. (dec)	Max. (dec)	Access
	Inst.	Atr.							
103	1	1	Function of I/O (input/output)	8	BYTE	1	0	1	Set
		2	Activation (high-active/low-active)	8	BYTE	0	0	1	Set
		3	Output function	16	WORD	192	0	511	Set
		4	Input function	8	BYTE	0	0	3	Set
		5	Status (input/output)	8	BYTE	0	0	1	Get
		6	Output activation	8	BYTE	0	0	1	Set
103	2	1	Function of I/O (input/output)	8	BYTE	1	0	1	Set
		2	Activation (high-active/low-active)	8	BYTE	0	0	1	Set
		3	Output function	16	WORD	56	0	511	Set
		4	Input function	8	BYTE	0	0	3	Set
		5	Status (input/output)	8	BYTE	0	0	1	Get
		6	Output activation	8	BYTE	0	0	1	Set

9.6.6.1 Definition of input/output

Instance 1, attribute 1 (PIN 2/M12 Power)

Instance 2, attribute 1 (PIN 4/M12 Power)

This attribute defines whether the function of PIN 2/PIN 4 at the M12 Power connection is an input or output.

1 = Output

0 = Input

Attribute description for cases where attribute 1 in instance 1 or 2 is selected as a switching input.

9.6.6.2 Activation for inputs

Instance 1, attribute 2 (PIN 2/M12 Power)

Instance 2, attribute 2 (PIN 4/M12 Power)

The switching input of the AMS 355*i* is edge-triggered.

0 = Switching input reacts to a falling edge (transition from logical 1 to 0)

1 = Switching input reacts to a rising edge (transition from logical 0 to 1)

9.6.6.3 Function assignment of inputs

Instance 1, attribute 4 (PIN 2/M12 Power)

Instance 2, attribute 4 (PIN 4/M12 Power)

Attribute 4 determines which function is to be triggered in the AMS 355/i when the input is set.

Bit 7	Bit 6	Bit 5	Bit 4	Bit 3	Bit 2	Bit 1	Bit 0
-	-	-	-	-	-	Laser ON/ OFF	Preset teach

Bit 0 = Preset teach

The switching input reacts to the edge set in attribute 2. The preset value is adopted at the position at which the switching input detects an edge change as defined in attribute 2.

Bit 1 = Laser ON/OFF

The switching input reacts to the edge set in attribute 2. The laser is switched OFF if the switching input detects an edge change as described in attribute 2. If an opposing edge is detected at the switching input, the laser is switched ON again.

9.6.6.4 Input function state

Instance 1, attribute 5 (PIN 2/M12 Power)

Instance 2, attribute 5 (PIN 4/M12 Power)

0 = Input function is not active. Neither Laser ON/OFF nor Preset teach is active.

1 = Input function is active. Laser ON/OFF or Preset teach or both has been activated.

Attribute description for cases where attribute 1 in instance 1 or 2 is selected as a switching output.

9.6.6.5 Activation for outputs

Instance 1, attribute 2 (PIN 2/M12 Power)

Instance 2, attribute 2 (PIN 4/M12 Power)

The attribute defines the level of the output at which the "Output" event occurs.

0 = from logical 1 to logical 0 if the "output" event occurs (see Attribute 3)

1 = from logical 0 to logical 1 if the "output" event occurs (see Attribute 3)

9.6.6.6 Function assignment of hardware outputs

Instance 1, attribute 3 (PIN 2/M12 Power)

Instance 2, attribute 3 (PIN 4/M12 Power)

The attribute defines which event triggers activation of the output. The individual functions are OR-linked.

Bit 7	Bit 6	Bit 5	Bit 4	Bit 3	Bit 2	Bit 1	Bit 0
Hardware (ERR)	Plausibility (PLB)	Laser (LSR)	Temperature (TMP)	Intensity (ATT)	Velocity limit value violated	Reserved	
Bit 15	Bit 14	Bit 13	Bit 12	Bit 11	Bit 10	Bit 9	Bit 8
Reserved							Dynamic output

For instance 1 attribute 3, the default $192_d / 00 C0_h / 0000 0000 1100 0000_b$ is specified. This means that an edge change, as defined in attribute 2, takes place at the output (PIN 2) if the ERR or PLB message occurs.

For instance 2 attribute 3, the default $56_d / 00 38_h / 0000 0000 0011 1000_b$ is specified. This means that an edge change, as defined in attribute 2, takes place at the output (PIN 4) if the LSR or TMP or ATT message occurs.

9.6.6.7 Output function state

Instance 1, attribute 5 (PIN 2/M12 Power)

Instance 2, attribute 5 (PIN 4/M12 Power)

- 0 = Output function is not active. No event from attribute 3 is active.
- 1 = Output function is active. At least one event from attribute 3 is activated.

9.6.6.8 Activation of output (dynamic output)

Instance 1, attribute 6 (PIN 2/M12 Power)

Instance 2, attribute 6 (PIN 4/M12 Power)

With the dynamic output, the hardware outputs (PIN 2/PIN 4) can be set using the control software.

Actuation takes place via bit 8.

- 0 = Dynamic output active
- 1 = The hardware output(s) are set as defined in attribute 2

Dynamic setting of the outputs is performed via 256_d (256 = without taking the status messages bit 7 to bit 2 into consideration).

9.6.7 Class 104 Error handling procedures

Services:

- Get Attribute Single
- Set Attribute Single

Cl.	Path		Designation	Size in bit	Data type	Default (dec)	Min. (dec)	Max. (dec)	Access
	Inst.	Attr.							
104	1	1	Position value in the case of failure	8	BYTE	1	0	1	Set
		2	Suppress position status	8	BYTE	1	0	1	Set
		3	Error delay (position)	8	BYTE	1	0	1	Set
		4	Error delay time (position)	16	UINT	100	100	1,000	Set
		5	Velocity in the case of failure	8	BYTE	1	0	1	Set
		6	Suppress velocity status	8	BYTE	1	0	1	Set
		7	Error delay (velocity)	8	BYTE	1	0	1	Set
		8	Error delay time (velocity)	16	UINT	200	200	1,000	Set

9.6.7.1 Position value in the case of failure

Attribute 1

The attribute specifies which position is transferred, in the event of an error, after the "Position error delay time" has elapsed.

- 0 = Last valid value
- 1 = Value 0

9.6.7.2 Position status error delay

Attribute 2

The attribute specifies whether the PLB status bit (implausible measurement value) is set immediately or after the "Position error delay time" has elapsed.

- 0 = PLB status bit is set immediately
- 1 = PLB status bit is set after the delay

9.6.7.3 Position error delay

Attribute 3

The attribute specifies whether, in the event of an error, the position value outputs the value of attribute 1 immediately (0 or last valid value) or outputs the last valid position value for the configured error delay time (attribute 4).

- 0 = Error delay deactivated
- 1 = Error delay activated

9.6.7.4 Position error delay time

Attribute 4

Errors which occur are suppressed for the configured time. If no valid position value can be ascertained during the configured time, the last valid position value is output. If the error persists after the time elapses, the value configured in the "Position value in the case of failure" attribute (attribute 1) is output. The error delay time is specified in milliseconds [ms] and must be between 100 and 1000.

9.6.7.5 Velocity in the case of failure

Attribute 5

The attribute specifies which velocity is transferred, in the event of an error, after the "Velocity error delay time" has elapsed.

0 = Last valid value

1 = Value 0

9.6.7.6 Velocity status error delay

Attribute 6

The attribute specifies whether the PLB status bit (implausible measurement value) is set immediately or after the "Velocity error delay time" has elapsed.

0 = PLB status bit is set immediately

1 = PLB status bit is set after the delay

9.6.7.7 Velocity error delay

Attribute 7

The attribute specifies whether, in the event of an error, the velocity value outputs the value of attribute 5 immediately (0 or last valid value) or outputs the last valid velocity value for the configured error delay time (attribute 8).

0 = Error delay deactivated

1 = Error delay activated

9.6.7.8 Velocity error delay time

Attribute 8

Errors which occur are suppressed for the configured time. If no valid velocity value can be ascertained during the configured time, the last valid velocity value is output. If the error persists after the time elapses, the value configured in the "Velocity in the case of failure" attribute (attribute 5) is output. The error delay time is specified in milliseconds [ms] and must be between 200 and 1000.

9.6.8 Class 105 Velocity monitoring

Class 105, instance 1: attributes for velocity limit value 1

Class 105, instance 2: attributes for velocity limit value 2

Class 105, instance 3: attributes for velocity limit value 3

Class 105, instance 4: attributes for velocity limit value 4

Services:

- Get Attribute Single
- Set Attribute Single

Cl.	Path		Designation	Size in bit	Data type	Default (dec)	Min. (dec)	Max. (dec)	Access
	Inst.	Attr.							
105	1	1	Release	8	BYTE	0	0	1	Set
		2	Switching type	8	BYTE	0	0	1	Set
		3	Direction selection	8	BYTE	0	0	1	Set
		4	Velocity limit value	16	UINT	0	0	20,000	Set
		5	Velocity hysteresis	16	UINT	100	0	20,000	Set
		6	Limit value range start	32	DINT	0	-999,999	999,999	Set
		7	Limit value range end	32	DINT	0	-999,999	999,999	Set
		8	Status limit value	8	BYTE	0	0	1	Get
		9	Limit value comparison	8	BYTE	0	0	1	Get
105	2	1	Release	8	BYTE	0	0	1	Set
		2	Switching type	8	BYTE	0	0	1	Set
		3	Direction selection	8	BYTE	0	0	1	Set
		4	Velocity limit value	16	UINT	0	0	20,000	Set
		5	Velocity hysteresis	16	UINT	100	0	20,000	Set
		6	Limit value range start	32	DINT	0	-999,999	999,999	Set
		7	Limit value range end	32	DINT	0	-999,999	999,999	Set
		8	Status limit value	8	BYTE	0	0	1	Get
		9	Limit value comparison	8	BYTE	0	0	1	Get
105	3	1	Release	8	BYTE	0	0	1	Set
		2	Switching type	8	BYTE	0	0	1	Set
		3	Direction selection	8	BYTE	0	0	1	Set
		4	Velocity limit value	16	UINT	0	0	20,000	Set
		5	Velocity hysteresis	16	UINT	100	0	20,000	Set
		6	Limit value range start	32	DINT	0	-999,999	999,999	Set
		7	Limit value range end	32	DINT	0	-999,999	999,999	Set
		8	Status limit value	8	BYTE	0	0	1	Get
		9	Limit value comparison	8	BYTE	0	0	1	Get
105	4	1	Release	8	BYTE	0	0	1	Set
		2	Switching type	8	BYTE	0	0	1	Set
		3	Direction selection	8	BYTE	0	0	1	Set
		4	Velocity limit value	16	UINT	0	0	20,000	Set
		5	Velocity hysteresis	16	UINT	100	0	20,000	Set
		6	Limit value range start	32	DINT	0	-999,999	999,999	Set
		7	Limit value range end	32	DINT	0	-999,999	999,999	Set
		8	Status limit value	8	BYTE	0	0	1	Get
		9	Limit value comparison	8	BYTE	0	0	1	Get

The described attributes each apply to instances 1 - 4

9.6.8.1 Velocity limit value - Release

Attribute 1

The attribute activates the respective velocity monitoring.

0 = Inactive

1 = Active

9.6.8.2 Velocity limit value - Switching type

Attribute 2

The attribute specifies whether the velocity limit value is to be checked for overshooting or undershooting (attribute 3 and 4).

0 = Check for value greater than limit

1 = Check for value less than limit

9.6.8.3 Velocity limit value - Direction selection

Attribute 3

The attribute specifies whether the velocity check is to be performed direction-dependent or direction-independent.

If a direction-dependent limit value check is activated via attribute 2, the values of range start and range end also define the direction. The check is always performed from range start to range end. For example, if the range start is "5500" and the range end is "5000", the direction-dependent check is only performed in the direction from "5500" to "5000". The limit value is not active in the opposite direction.

If the check is independent of direction, the order of range start and range end is irrelevant.

In the case of overshooting or undershooting, the limit value status (attribute 7) and, where applicable, the output are set via class 103, instance 1 or 2, attribute 3 (depending on the selected switching type).

0 = Direction independent

1 = Direction dependent

9.6.8.4 Velocity limit value - Velocity limit value

Attribute 4

The limit value configured in attribute 3 is compared with the measured ACTUAL velocity. The entry is made in mm/s or inch/100s.

9.6.8.5 Velocity limit value - Velocity hysteresis

Attribute 5

Attribute 4 describes the switching hysteresis for the value entered in attribute 3 to prevent signal bouncing. The entry is made in mm/s or inch/100s.

9.6.8.6 Velocity limit value - Limit value range start

Attribute 6

The limit value is monitored beginning at this position. The value is specified in mm or inch/100.

If the values for range start and range end are identical, velocity monitoring is active over the entire traversing range.

9.6.8.7 Velocity limit value - Range end limit value

Attribute 7

The limit value is monitored up to this position. The value is specified in mm or inch/100.

If the values for range start and range end are identical, velocity monitoring is active over the entire traversing range.

9.6.8.8 Velocity limit value - Status limit value

Attribute 8

The attribute signals exceedance of the configured limit values.

0 = Limit values observed

1 = Limit values exceeded

9.6.8.9 Velocity limit value - Limit value comparison

Attribute 9

The attribute indicates whether the respective velocity limit value is compared with the configured limit value.

0 = Comparison not active

1 = Comparison active

10 Diagnostics and troubleshooting

10.1 Service and diagnosis in the display of the AMS 355/

In the main menu of the AMS 355/, expanded "Diagnostics" can be called up under the Service heading.

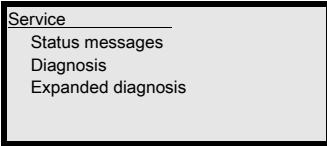

From the Service main menu, press the enter button (↵) to access the underlying menu level. Use the up/down buttons (▲ ▼) to select the corresponding menu item in the selected level; use the enter button (↵) to activate the selection. Return from any sub-level to the next-higher menu item by pressing the ESC button (⏏).

10.1.1 Status messages

The status messages are written in a ring memory with 25 positions. The ring memory is organized according to the FIFO principle. No separate activation is necessary for storing the status messages. Power OFF clears the ring memory.



Basic representation of the status messages

n: Type / No. / 1

Meaning:

n: memory position in the ring memory

Type: type of message:

I = info, W = warning, E = error, F = severe system error.

No: internal error detection

1: frequency of the event (always "1" because no summation occurs)

The status messages within the ring memory are selected with the up/down buttons (▲ ▼). Use the enter button (↵) to call up **detailed information** about the respective status message:

Detailed information about a status message

Type: type of message + internal counter
UID: Leuze-internal coding of the message
ID: description of the message
Info: not currently used

Within the detailed information, press the enter button  again to activate an **action menu** with the following functions:



- Acknowledge message
- Delete message
- Acknowledge all
- Delete all

10.1.2 Diagnosis

The diagnostics function is activated by selecting the Diagnostics menu item. The ESC button  deactivates the diagnostics function and clears the contents of the recordings.

The recorded diagnostic data is displayed in 2 fields. In the upper half of the display, status messages of the AMS and the bar graph are displayed. The lower half contains information used for Leuze-internal evaluation.

IO1	LSR	PLB	
IO2	TMP	ATT	
ERR			
Pos. act.:		-----	
Pos. min.:		-----	
Pos. max.:		-----	

Use the up/down buttons   to scroll in the bottom half between various displays. The contents of the scrollable pages are intended solely for Leuze for internal evaluation.

The diagnostics have no influence on communication with the host interface and can be activated during operation of the AMS 355*i*.

10.1.3 Expanded diagnosis

The Expanded diagnosis menu item is used for Leuze-internal evaluation.

10.2 General causes of errors

The LEDs for PWR and Net are designed as bicolor LEDs. A change in color from red/green and a static/flashing display provide information for further diagnosis.

After power ON, the Power LED and Net LED are tested as follows:

1. LEDs off.
2. LEDs are switched to green for approx. 0.25s.
3. LEDs are switched to red for approx. 0.25s.
4. LEDs off.

This is followed by the status display for the Power LED (see chapter 9.3) and the Net LED.

10.2.1 Power LED

See also Chapter 8.2.2.

Error	Possible error cause	Measure
PWR LED "OFF"	No supply voltage connected	Check supply voltage.
	Hardware error	Send in device.
PWR LED "flashes red"	Light beam interruption	Check alignment.
	Plausibility error	Traverse rate >10m/s.
PWR LED "static red"	Hardware error	For error description, see display, It may be necessary to send in the device.

Table 10.1: General causes of errors

10.3 Interface errors

10.3.1 NET LED



Note!

DeviceNet scanners from Rockwell Automation display an error code via a 2-digit display. The error code provides further information on possible failure causes.

For further information on the LED status displays.

Error	Possible error cause	Measure
NET LED "OFF"	Power off on AMS 355 <i>i</i>	Check supply voltage/wiring.
	Bus OFF by scanner	Switch bus online.
	No V+/V-	Check V+/V-.
	DUP MAC ID test running	
NET LED "flashes red"	Time-out in bus communication	
	AMS 355 <i>i</i> /not in the scanner scan list	Is AMS 355 <i>i</i> present in the scan list, or is DeviceNet deactivated on the AMS 355 <i>i</i> ?
	General network error	Check termination. Check wiring
	Wrong baud rate selected	Check V+/V-. Check baud rate setting. Note error code on scanner.
NET LED "static red"	No bus communication	Perform reset on scanner. Change scanner. Note error code on scanner.
	Wrong baud rate selected	Check baud rate setting.
NET LED "flashes green"	No communication can be established	AMS 355 <i>i</i> present in the scan list?
	The AMS 355 <i>i</i> is not listed in the scan list of the master	Bus off on scanner. Note error code on scanner.
NET LED "flashes green/red"	The AMS 355 <i>i</i> has detected a violation of the communication rules. Bit Error Acknowledgment error Stuff error CRC error Form error	Note error code on scanner.

Table 10.2: Bus error

10.4 Status indicators in the display of the AMS 355*i*

Display	Possible error cause	Measure
PLB (implausible measurement values)	Laser beam interruption	Laser spot must always be incident on the reflector.
	Laser spot outside of reflector	Traverse rate < 10m/s?
	Measurement range for maximum distance exceeded	Restrict traversing path or select AMS with larger measurement range.
	Velocity greater than 10m/s	Reduce velocity.
	Ambient temperature far outside permissible range (TMP display; PLB)	Select AMS with heating or ensure cooling.

Display	Possible error cause	Measure
ATT (insufficient received signal level)	Reflector soiled	Clean reflector or glass lens.
	Glass lens of the AMS soiled	
	Performance reduction due to snow, rain, fog, condensing vapor or heavily polluted air (oil mist, dust)	Optimize usage conditions.
	Laser spot only partially on reflector	Check alignment.
TMP (operating temperature outside of specification)	Protective film on reflector	Remove protective film from reflector.
	Ambient temperatures outside specified range	In case of low temperatures, remedy may be an AMS with heating. If temperatures are too high, provide cooling or change mounting location.
LSR Laser diode warning	Laser diode prefailure message	Send in device at next possible opportunity to have laser diode replaced. Have replacement device ready.
ERR Hardware error	Indicates an uncorrectable error in the hardware	Send in device for repair.

Service hotline:

You can find the contact information for the hotline in your country on our website www.leuze.com under "Contact & Support".

Repair service and returns:

Defective devices are repaired at our service centers competently and quickly. We offer you an extensive service packet to keep any system downtimes to a minimum. Our service center requires the following information:

- Your customer number
- Product description or part description
- Serial number and batch number
- Reason for requesting support together with a description

For this purpose, please register the merchandise concerned. Simply register return of the merchandise on our website www.leuze.com under Contact & Support -> Repair Service & Returns:

To ensure quick and easy processing of your request, we will send you a returns order with the returns address in digital form.

**Note!**

Please use Chapter 10 as a master copy should servicing be required.

Cross the items in the "Measures" column which you have already examined, fill out the following address field and fax the pages together with your service contract to the fax number listed below.

Customer data (please complete)

Device type:	
Company:	
Contact person/department:	
Phone (direct dial):	
Fax:	
Street / no.:	
ZIP code / City:	
Country:	

Leuze Service fax number:

+49 7021 573 - 199

11 Type overview and accessories

11.1 Part number code

AMS 3xx / yyy H

Heating option	H =	With heating
Operating range	40	Max. operating range in m
	120	Max. operating range in m
	200	Max. operating range in m
	300	Max. operating range in m
	i =	Integrated fieldbus technology
Interface	00	RS 422/RS 232
	01	RS 485
	04	PROFIBUS DP / SSI
	08	TCP/IP
	35	CANopen
	38	EtherCAT
	48	PROFINET RT
	55	DeviceNet
	58	EtherNet/IP
	84	Interbus

AMS Absolute Measurement System

11.2 Overview of AMS 355/i types (DeviceNet)

Type designation	Description	Part no.
AMS 355/40	40m operating range, DeviceNet interface	50113717
AMS 355/120	120m operating range, DeviceNet interface	50113718
AMS 355/200	200m operating range, DeviceNet interface	50113719
AMS 355/300	300m operating range, DeviceNet interface	50113720
AMS 355/40 H	40m operating range, DeviceNet interface, integrated heating	50113721
AMS 355/120 H	120m operating range, DeviceNet interface, integrated heating	50113722
AMS 355/200 H	200m operating range, DeviceNet interface, integrated heating	50113723
AMS 355/300 H	300m operating range, DeviceNet interface, integrated heating	50113724

Table 11.1: Overview of AMS 355/i types

11.3 Overview of reflector types

Type designation	Description	Part no.
REF 4-A-150x150	Reflective tape, 150x150mm, self-adhesive	50141015
Reflective tape 200x200-S	Reflective tape, 200x200mm, self-adhesive	50104361
REF 4-A-300x300	Reflective tape, 300x300mm, self-adhesive	50141014
Reflective tape 500x500-S	Reflective tape, 500x500mm, self-adhesive	50104362
Reflective tape 914x914-S	Reflective tape, 914x914mm, self-adhesive	50108988
Reflective tape 200x200-M	Reflective tape, 200x200mm, affixed to carrier plate	50104364
Reflective tape 500x500-M	Reflective tape, 500x500mm, affixed to carrier plate	50104365
Reflective tape 914x914-M	Reflective tape, 914x914mm, affixed to carrier plate	50104366
Reflective tape 200x200-H	Reflective tape, 200 x 200mm, heated	50115020
Reflective tape 500x500-H	Reflective tape, 500 x 500mm, heated	50115021
Reflective tape 914x914-H	Reflective tape, 914 x 914mm, heated	50115022

Table 11.2: Overview of reflector types

11.4 Accessories

11.4.1 Accessories – Mounting bracket

Type designation	Description	Part no.
MW OMS/AMS 01	Mounting bracket for mounting AMS 355/ to horizontal surfaces	50107255

Table 11.3: Accessories – Mounting bracket

11.4.2 Accessories – Deflector unit

Type designation	Description	Part no.
US AMS 01	Deflector unit with integrated mounting bracket for AMS 355/ Variable 90° deflection of laser beam in different directions	50104479
US 1 OMS	Deflector unit without mounting bracket for simple 90° deflection of laser beam	50035630

Table 11.4: Accessories – Deflector unit

11.4.3 Accessories – M12 connector

Type designation	Description	Part no.
KD 01-5-BA	M12 connector, A-coded socket, 5-pin, BUS IN	50040097
KD 01-5-SA	M12 connector, A-coded connector, 5-pin, BUS OUT	50040098
KD 095-5A	M12 connector, A-coded socket, 5-pin, Power (PWR)	50020501

Table 11.5: Accessories – M12 connector

11.4.4 Accessories – Terminating resistor

Type designation	Description	Part no.
TS 01-4-SA	120 ohm M12 terminating resistor for DeviceNet BUS OUT	50040099

Table 11.6: Accessories – Terminating resistor

11.4.5 Accessories – Ready-made cables for voltage supply

Contact assignment/core color of PWR connection cable

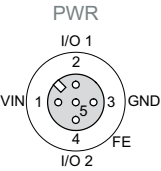
PWR connection cable (5-pin socket, A-coded)			
	Pin	Name	Core color
 <p>M12 socket (A-coded)</p>	1	VIN	Brown
	2	I/O 1	White
	3	GND	Blue
	4	I/O 2	Black
	5	FE	Gray
	Thread	FE	Bare

Technical data of the cables for voltage supply

Operating temperature range In idle state: -30°C ... +70°C
In motion: -5°C ... +70°C

Material Sheathing: PVC

Bending radius > 50 mm

Order codes of the cables for voltage supply

Type designation	Description	Part no.
K-D M12A-5P-5m-PVC	M12 socket, A-coded, axial connector outlet, open cable end, cable length 5m	50104557
K-D M12A-5P-10m-PVC	M12 socket, A-coded, axial connector outlet, open cable end, cable length 10m	50104559

11.4.6 Accessories - Ready-made cables for DeviceNet

Contact assignment of DeviceNet connection cable

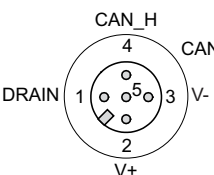
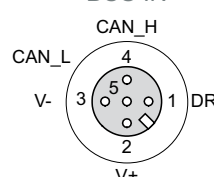
DeviceNet connection cable (5-pin socket/connector, A-coded)				
	Pin	Name	Core color	Comment
<p>BUS OUT</p>  <p>M12 socket (A-coded)</p> <p>BUS IN</p>  <p>M12 connector (A-coded)</p>	1	Drain	-	Shield
	2	V+	Red	Data V+ supply voltage
	3	V-	Black	Data V- supply voltage
	4	CAN_H	White	Data signal CAN_H
	5	CAN_L	Blue	Data signal CAN_L
	Thread	FE	-	Functional earth (housing)

Technical data of the DeviceNet connection cable

Operating temperature range

In idle state: -40°C ... +80°C

In motion: -5°C ... +80°C

Material

The cables fulfill the DeviceNet requirements and are free of halogens, silicone, and PVC

Bending radius

> 80mm, suitable for drag chains

Order codes for DeviceNet connection cables

Type designation	Comment	Part no.
KB DN/CAN-2000-BA	M12 socket for BUS IN, axial connector, open cable end, cable length 2m	50114692
KB DN/CAN-5000-BA	M12 socket for BUS IN, axial connector, open cable end, cable length 5m	50114696
KB DN/CAN-10000-BA	M12 socket for BUS IN, axial connector, open cable end, cable length 10m	50114699
KB DN/CAN-30000-BA	M12 socket for BUS IN, axial connector, open cable end, cable length 30m	50114701
KB DN/CAN-2000-SA	M12 connector for BUS OUT, axial connector, open cable end, cable length 2m	50114693
KB DN/CAN-5000-SA	M12 connector for BUS OUT, axial connector, open cable end, cable length 5m	50114697
KB DN/CAN-10000-SA	M12 connector for BUS OUT, axial connector, open cable end, cable length 10m	50114700
KB DN/CAN-30000-SA	M12 connector for BUS OUT, axial connector, open cable end, cable length 30m	50114702
KB DN/CAN-1000-SBA	M12 connector + M12 socket for DeviceNet, axial connectors, cable length 1m	50114691
KB DN/CAN-2000-SBA	M12 connector + M12 socket for DeviceNet, axial connectors, cable length 2m	50114694
KB DN/CAN-5000-SBA	M12 connector + M12 socket for DeviceNet, axial connectors, cable length 5m	50114698

12 Maintenance

12.1 General maintenance information

With normal use, the laser measurement system does not require any maintenance by the operator.

Cleaning

In the event of dust build-up or if the warning message (ATT) is displayed, clean the device with a soft cloth; use a cleaning agent (commercially available glass cleaner) if necessary. Also check the reflector for possible soiling.



Attention!

Do not use solvents and cleaning agents containing acetone. The use of such solvents can dull the reflector, the housing window and the display.

12.2 Repairs, servicing



Attention!

Access to or changes on the device, except where expressly described in this operating manual, is not authorized. The device must not be opened. Failure to comply will render the guarantee void. Warranted features cannot be guaranteed after the device has been opened.

Repairs to the device must only be carried out by the manufacturer.

 *Contact your Leuze distributor or service organization should repairs be required. The addresses can be found on the inside of the cover and on the back.*



Note!

When sending laser measurement systems to Leuze for repair, please provide an accurate description of the fault.

12.3 Disassembling, packing, disposing

Repacking

For later reuse, the device is to be packed so that it is protected.

Note!

Electrical scrap is a special waste product! Observe the locally applicable regulations regarding disposal of the product.

A		Direction Counting	66
Accessories	89	Direction counting	67
Accessories – Deflector unit	90	Direction of movement	70
Accessories – M12 connector	90	Display	40
Accessories – Mounting bracket	90		
Accessories – Ready-made cables	91	E	
Accessories – Terminating resistor	91	EDS file	13, 55, 58
Accuracy	14	Detailed description	60
Activation for inputs	75	Electrical connection	37
Activation for outputs	76	Safety notices	37
Activation of output (dynamic output)	77	Expanded diagnosis	84
Air humidity	15	Explanation of symbols	5
Alarm flag	68	Extended heating control	73
Alarms	68		
Alignment	20	F	
		Fast commissioning	12
C		Free resolution	71
Cleaning	94	Function assignment of hardware outputs	77
Connections		Function assignment of inputs	76
DeviceNet BUS IN	38		
DeviceNet BUS OUT	39	G	
PWR IN	38	General causes of errors	85
Service	39		
Contouring error calculation	14	H	
Contrast	73	Heated reflectors	
Control buttons	43	Dimensioned drawing	31
Control panel	40	Technical data	30
D		I	
Data V+ / Data V- supply voltage	57	Illumination	72
Declaration of Conformity	5	Input assembly	73
Definition of input/output	75	Input function state	76
Deflector unit		Installation	18
Maximum operating range	24	Interface errors	86
With integrated mounting bracket	24	Interface info in display	41
Without mounting bracket	26	Internal hardware error	41
Deflector unit US 1 OMS			
Dimensioned drawing	26	L	
Deflector unit US AMS 01		Language selection	72
Dimensioned drawing	25	Laser diode control	71
Description of functions	6	Laser diode status	71
Device type	63		
DeviceNet address entry	57	M	
DeviceNet installation	54	MAC ID	53, 57
DeviceNet interface	53	Main menu	
Diagnosis	83	Device information	44
Dimensioned drawing of AMS 3xxi	16	Language selection	45

Network information	44	Position error delay time	79
Parameter	45	Position format	66
Service	45	Position sensor type	66
Status and measurement data	45	Position status error delay	78
Maintenance	94	Position value	60, 65
Measurement range	14	Position value + status	60
Menus		Position value in the case of failure	78
Language selection menu	50	Prefailure message	40
Main menu	44	Preset reset	70
Parameter menu	45	Preset status	70
Service menu	50	Preset teach	70
Mounting	19	Preset toggle	70
With laser beam deflector unit	24	Preset value	69
Mounting bracket (optional)	21	Preset value + control	62
Movement status	71	Product Code	63
		Product Name	64
N		PWR LED	42
Name plates	18		
NET LED	43	Q	
		Quality assurance	5
O			
ODVA	53	R	
Offset value	71	Received signal	41
Operating principle	12	Reflective tape	
Operating range	89	Dimensioned drawing	29
Operating temperature	15	Technical data	28
Operating time	69	Reflector	27
Operation	40, 51	Mounting	33
Output assembly	74	Pitch	36
Output function state	77	Size	32
Output time	14	Type overview	32
Overview of reflector types	90	Repair	94
		Response time	14
P		Revision	63
Package contents	18		
Parallel mounting	22	S	
Parameter enable	51, 52	Serial number	64
Parameter menu		Servicing	94
DeviceNet	46	Status	63
I/O	47	Status and warning messages	40
Other	49	Status indicator	40
Parameter handling	45	ATT	87
Position value	46	ERR	87
Password	72	PLB	86
Password protection	72	TMP	87
Plausibility error	40	Status indicator – LSR	87
Position error delay	78	Status indicators	41

Status indicators in the display	86
Status messages	83
Storage	18
Storage temperature	15
Supply voltage	14
Supported alarm	68
Supported warnings	69
Surface reflections	34
Symbols	5

T

Technical data	14
Dimensioned drawing	16
General specifications	14
Reflective tapes	27
Temperature monitoring	40
Transport	18
Troubleshooting	83
Trunk Line	53
Type overview	17, 89

V

Velocity error delay	79
Velocity error delay time	79
Velocity format	67
Velocity free resolution	67
Velocity in the case of failure	79
Velocity limit value	
Direction selection	81
Limit value comparison	82
Limit value range end	82
Limit value range start	82
Release	81
Status limit value	82
Switching type	81
Velocity hysteresis	81
Velocity limit value	81
Velocity status error delay	79
Velocity value	66
Velocity value + state	61
Vendor ID	63

W

Warning flag	69
Warnings	69

Level 1 ▲▼ : Selection	Level 2 ▲▼ : Selection ESC : Back	Level 3 ▲▼ : Selection ESC : Back	Level 4 ▲▼ : Selection ESC : Back	Level 5 ▲▼ : Selection ESC : Back	Selection/configuration option ▲▼ : Selection ↵ : Activate ESC : Back	Detailed information on	
Device information						Page 44	
Network information						Page 44	
Status and measurement data						Page 44	
Parameter	↵ Parameter handling	↵ Parameter enable			ON/OFF	Page 45	
		↵ Password	↵ Activate password		ON/OFF		
			↵ Password entry		For setting a four-digit numerical password		
		↵ Parameters to default		All parameters are reset to their factory settings			
	↵ DeviceNet	↵ Activation			ON/OFF	Page 46	
		↵ Node ID					
		↵ Baud rate			125 kbit/s / 250 kbit/s / 500 kbit/s		
	↵ Position value	↵ Unit				Metric/Inch	Page 46
		↵ Counting direction				Positive/Negative	
		↵ Offset				Value input:	
↵ Preset					Value input		
↵ Error delay					ON/OFF		
↵ Position value in the case of failure					Last valid value / zero		
↵ Free resolution value					5 ...50000		
↵ I/O	↵ I/O 1	↵ Port configuration	↵ Switching input	↵ Function	Input/Output	Page 47	
			↵ Activation	No function/teach preset/laser ON/OFF			
		↵ Switching output	↵ Function	Low active/High active			
			↵ Activation	Pos. limit value 1 / Pos. limit value 2 / Velocity / Intensity (ATT) / Temp. (TMP) / Laser (LSR) / Plausibility (PLB) / Hardware (ERR)			
		↵ I/O 2	↵ Port configuration	↵ Switching input	↵ Function		Low active/High active
				↵ Activation	No function/teach preset/laser ON/OFF		
	↵ Switching output		↵ Function	Pos. limit value 1 / Pos. limit value 2 / Velocity / Intensity (ATT) / Temp. (TMP) / Laser (LSR) / Plausibility (PLB) / Hardware (ERR)			
	↵ Limit values	↵ Upper pos. limit 1	↵ Activation	↵ Limit value input	Low active/High active		
			↵ Limit value input	ON/OFF			
		↵ Lower pos. limit 1	↵ Activation	↵ Limit value input	Value input in mm or inch/100		
			↵ Limit value input	ON/OFF			
		↵ Upper pos. limit 2	↵ Activation	↵ Limit value input	Value input in mm or inch/100		
	↵ Limit value input		ON/OFF				
↵ Lower pos. limit 2	↵ Activation	↵ Limit value input	Value input in mm or inch/100				
	↵ Limit value input	ON/OFF					

	Other	Heating control		Standard (heating: on < 10°C, off > 15°C) / Extended (heating: on < 30°C, off > 35°C)	Page 49
		Display background		10 minutes/ON	
		Display contrast		Weak/Medium/Strong	
		Service RS232	Baud rate	57.6kbit/s / 115.2kbit/s	
			Format	8,e,1 / 8,n,1	
Language selection				Deutsch / English / Español / Français / Italiano	Page 50
Service	Status messages			Number of readings, reading gates, reading rate / non-reading rate etc.	Page 50
	Diagnosis			Only for use by Leuze personnel for service purposes	
	Expanded diagnosis			Only for use by Leuze personnel for service purposes	