



SLS46CK4 Single light beam safety device



© 2018

Leuze electronic GmbH & Co. KG

In der Braike 1

D-73277 Owen / Germany

Phone: +49 7021 573-0

Fax: +49 7021 573-199

<http://www.leuze.com>



info@leuze.com

1	About this document	4
1.1	Used symbols and signal words	4
2	Safety notices.....	5
2.1	Intended use and foreseeable misuse.....	5
2.1.1	Intended use.....	6
2.1.2	Foreseeable misuse	6
2.2	Competent persons	6
2.3	Responsibility for safety	7
2.4	Disclaimer	7
3	Device description	8
3.1	Operating indicator on the transmitter	8
3.2	Operation indicator on the receiver.....	8
4	Mounting.....	9
4.1	Multi-axis arrangement of transmitter and receiver	9
4.2	Safety distances	9
4.3	Distance to reflective surfaces.....	10
5	Electrical connection.....	12
5.1	Transmitter - pin assignment	12
5.2	Receiver - pin assignment	12
6	Starting up the device	13
7	Testing	14
7.1	Check before initial commissioning	14
7.2	Regular testing by competent personnel	14
8	Disposal	16
9	Technical data	17
9.1	General specifications	17
9.2	Dimensioned drawing	19
10	Ordering information and accessories	20
10.1	Article list.....	20
10.2	Accessories.....	21
11	EC Declaration of Conformity	25



1 About this document

1.1 Used symbols and signal words

Tab. 1.1: Warning symbols and signal words

	Symbol indicating dangers to persons
	Symbol indicating possible property damage
NOTE	Signal word for property damage Indicates dangers that may result in property damage if the measures for danger avoidance are not followed.
CAUTION	Signal word for minor injuries Indicates dangers that may result in minor injury if the measures for danger avoidance are not followed.
WARNING	Signal word for serious injury Indicates dangers that may result in severe or fatal injury if the measures for danger avoidance are not followed.
DANGER	Signal word for life-threatening danger Indicates dangers with which serious or fatal injury is imminent if the measures for danger avoidance are not followed.

Tab. 1.2: Other symbols

	Symbol for tips Text passages with this symbol provide you with further information.
	Symbol for action steps Text passages with this symbol instruct you to perform actions.

2 Safety notices

Before using the safety sensor, a risk assessment must be performed according to valid standards. For mounting, operation and tests, this document as well as all applicable national and international standards and regulations must be observed, printed out and handed to the affected personnel.





Before working with the safety sensor, completely read and observe the documents applicable to your task. In particular, the following national and international legal regulations apply for start-up, technical tests and handling of safety sensors:

- Machinery directive 2006/42/EC
- Use of work equipment directive
- Accident-prevention regulations and safety rules
- Other relevant standards
- Standards, e.g. EN ISO 13855



Area of application of the single light beam safety device

The single light beam safety device protects persons at access points or at points of operation of machines and systems.

The single light beam safety device is an electro-sensitive protective equipment (ESPE) only in connection with a MSI-TRM safety relay, in which the testing of transmitter and receiver is carried out in accordance with IEC/EN 61496-1, up to category 4 and PL e in accordance with EN ISO 13849-1.

	DANGER
	<p>Risk of death if start/restart is operated unintentionally!</p> <ul style="list-style-type: none"> ↳ The safety sensor detects persons only when they enter the danger zone but cannot tell whether there are any persons inside the danger zone. A start/restart interlock is therefore required. ↳ The acknowledgment unit for unlocking the start/restart interlock must not be reachable from the danger zone and must ensure a good view of the entire danger zone.
	DANGER
	<p>No protective function without adequate safety distance!</p> <p>Optical protective devices can only perform their protective function if they are mounted with adequate safety distance. The safety sensor does not provide a protective function without a sufficient safety distance.</p> <ul style="list-style-type: none"> ↳ When mounting, take all delay times into account, e.g. the response times of the safety sensor and control elements as well as the stopping time of the machine.
NOTICE	
	<ul style="list-style-type: none"> ↳ Observe the safety notices in the documentation of the connected test device. ↳ Ensure that the ESPE does not experience a dangerous failure due to glare from other light sources. Additional measures must be taken if necessary. ↳ The power supply unit used to operate the safety sensor has to be able to compensate for changes and interruptions of the operating voltage acc. to EN 61496-1.

2.1 Intended use and foreseeable misuse

	DANGER
	<p>Electrically live systems pose a risk of electric shock!</p> <ul style="list-style-type: none"> ↳ Make certain that, during all conversions, maintenance work and inspections, the system is securely shut down and protected against being restarted. ↳ Only have work on the electrical system and electronics performed by a competent person (see chapter 2.2 "Competent persons").

2.1.1 Intended use

Only if the safety sensor is correctly connected and correctly started up is the protective function of the protective device ensured. To prevent misuse and resulting dangers, the following must be observed:

- These operating instructions are included in the documentation of the system on which the protective device is mounted and are available to the operating personnel at all times.
- The safety sensor may only be used after it has been selected in accordance with the respectively applicable instructions and relevant standards, rules and regulations regarding labor protection and safety at work, and after it has been installed on the machine, connected, commissioned, and checked by a competent person (see chapter 2.2 "Competent persons").
- The safety sensor must only be connected and commissioned in accordance with its specifications (technical data, environmental conditions, etc.).
- The acknowledgment unit for unlocking the start/restart interlock must be located outside of the danger zone.
- The entire danger zone must be visible from the installation site of the acknowledgment unit.
- The construction of the safety sensor must not be altered. When manipulating the safety sensor, the protective function is no longer guaranteed. Manipulating the safety sensor also voids all warranty claims against the manufacturer of the safety sensor.
- The safety sensor must be inspected regularly by a competent person to ensure proper integration and mounting (see chapter 2.2 "Competent persons").
- The safety sensor must be exchanged after a maximum of 20 years. Repairs or the exchange of wear parts do not extend the mission time.

2.1.2 Foreseeable misuse

Any use other than that defined under the "Approved purpose" or which goes beyond that use is considered improper use.

The user must ensure that other types of light beam do **not** influence the electro-sensitive protective equipment, e.g.

- Wireless control devices on cranes
- Radiation from welding sparks
- Stroboscopic lights

2.2 Competent persons

Connecting, mounting, commissioning and adjustment of the safety sensor must only be carried out by competent persons.

Prerequisites for competent persons:

- They have a suitable technical education.
- They know the rules and regulations for labor protection, safety at work and safety technology and can assess the safety of the machine.
- They know the operating instructions for the safety sensor and the machine.
- They have been instructed by the responsible person on the mounting and operation of the machine and of the safety sensor.
- They perform a task related to the subject matter shortly thereafter and keep their knowledge up to date through continuous further training.

Certified electricians

Electrical work must be carried out by a certified electrician.

Due to their technical training, knowledge and experience as well as their familiarity with relevant standards and regulations, certified electricians are able to perform work on electrical systems and independently detect possible dangers.

In Germany, certified electricians must fulfill the requirements of accident-prevention regulations DGUV (German Social Accident Insurance) provision 3 (e.g. electrician foreman). In other countries, there are respective regulations that must be observed.

2.3 Responsibility for safety

Manufacturer and operator must ensure that the machine and implemented safety sensor function properly and that all affected persons are adequately informed and trained.

The type and content of all imparted information must not lead to unsafe actions by users.

The manufacturer of the machine is responsible for:

- Safe machine construction
- Safe implementation of the safety sensor, verified by the initial test performed by a competent person
- Imparting all relevant information to the operating company
- Adhering to all regulations and directives for the safe commissioning of the machine

The operator of the machine is responsible for:

- Instructing the operator
- Maintaining the safe operation of the machine
- Adhering to all regulations and directives for labor protection and safety at work
- Regular testing by competent persons

2.4 Disclaimer

Leuze electronic GmbH + Co. KG is not liable in the following cases:

- The safety sensor is not used as intended.
- Safety notices are not adhered to.
- Reasonably foreseeable misuse is not taken into account.
- Mounting and electrical connection are not properly performed.
- Proper function is not tested (see chapter 7 "Testing").
- Changes (e.g., constructional) are made to the safety sensor.

3 Device description

The single light beam safety devices of the SLS46C series are active opto-electronic protective devices. They satisfy the following standards:

- Type in accordance with IEC/EN 61496-1 -2: Type 4
- Performance Level (PL) in accordance with EN ISO 13849-1: PL e*)
- Category in accordance with EN ISO 13849-1: Cat. 4*)

*) : only in combination with a MSI-TRM safety relay, e.g. MSI-TRMB-01.

NOTICE	
	<p>↪ The SLS46CK4 safety sensors are a type 4 AOPD only in combination with the MSI-TRM safety relays.</p> <p>↪ Observe the operating instructions of the MSI-TRM safety relays for mounting, electrical connection and operation.</p>

3.1 Operating indicator on the transmitter

Located on the transmitter are two LEDs which serve as function indicator.



LED	Display	Meaning
1	Green, continuous light	Ready
2	Yellow, continuous light	Transmitter activated

3.2 Operation indicator on the receiver

Located on the receiver are two LEDs which serve as function indicator.

LED	Display	Meaning
1	Green, continuous light	Ready
2	Yellow, continuous light	Light path free, but no function reserve

4 Mounting

 WARNING	
	<p>Improper mounting may result in serious injury!</p> <p>The protective function of the safety sensor is only ensured if appropriately and professionally mounted for the respective, intended area of application.</p> <p>↳ Only allow the safety sensor to be installed by qualified persons (see chapter 2.2 "Competent persons").</p>

↳ Install the safety sensor using the relevant mounting systems (see chapter 10 "Ordering information and accessories").

4.1 Multi-axis arrangement of transmitter and receiver

With multi-axis installation of single light beam safety devices, the light beams must run parallel to the reference plane (e.g. to the floor) and must be aligned mutually parallel.

↳ Install adjacent devices with the opposite beam direction. Otherwise, the transmitter of one system can influence the receiver of the other system and impair safe functioning of the devices.

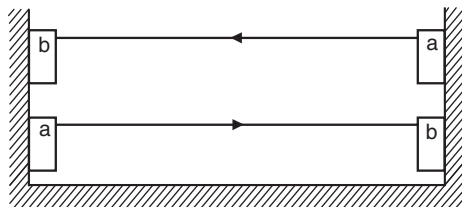

a Transmitter
b Receiver

Fig. 4.1: Beam direction with multi-axis arrangement



4.2 Safety distances

Optical protective devices can only perform their protective function if they are mounted with adequate safety distance.

The following standards specify formulas for calculating the safety distance:

- EN ISO 13855 "The positioning of protective devices in respect of approach speeds of parts of the human body": mounting situation and safety distances
- IEC/EN 61496-2 "Active optoelectronic protective devices": distance of the reflecting surfaces/deflecting mirrors

NOTICE	
	<p>Note the delay times!</p> <p>↳ When mounting, take all delay times into account, e.g. the response times of the safety sensor and control elements as well as the stopping time of the machine.</p>

 DANGER	
	<p>Risk of death if the single light beam safety device is installed with the incorrect safety distance!</p> <p>If an interruption of the light beam occurs, the danger area may only be reached once the machine has already come to a dead stop.</p> <p>↳ Install the single light beam safety device with the correctly calculated safety distance as well as suitable beam distances from potentially dangerous movement.</p>

Calculating the safety distance

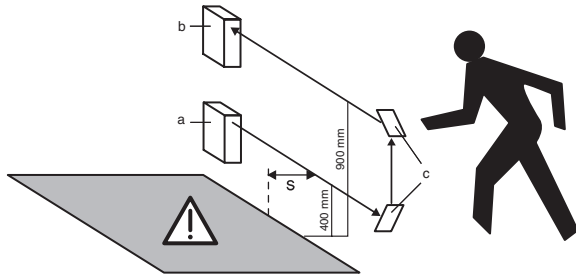

- a Transmitter
- b Receiver
- c Deflecting mirror

General formula for calculating the safety distance S of an Optoelectronic Protective Device acc. to EN ISO 13855

$$S = K \cdot T + C$$

- S [mm] = Safety distance between single light beam safety device and danger zone
- K [mm/s] = Approach speed (constant = 1600 mm/s)
- T [s] = Time delay between interruption of the light beam and stand-still of the machine.
- C [mm] = Additional distance to the safety distance: 850 mm or 1200 mm (see table)

Tab. 4.1: Beam spacing in accordance with EN ISO 13855

Number of beams	Heights above reference plane, e.g. floor [mm]	Additional distance C [mm]
1	750	1200
2	400, 900	850
3	300, 700, 1100	850
4	300, 600, 900, 1200	850

4.3 Distance to reflective surfaces

Ensure that the safety sensor is installed with sufficient distance between the optical axis and the reflective/mirroring surfaces.

WARNING

Failure to maintain minimum distances to reflective surfaces may result in serious injury!
 Reflective surfaces can indirectly deflect the transmitter beams to the receiver. In this case, interruption of the protective field is not detected.

- ↪ Determine the minimum distance a (see figure "Minimum distance from reflective surfaces").
- ↪ Make certain that all reflective surfaces are the necessary minimum distance away from the protective field according to IEC/EN 61496-2 (see diagrams "Minimum distance to reflective surfaces as a function of the protective field width").
- ↪ Check that reflective surfaces do not impair the detection capability of the safety sensor before start-up and at appropriate intervals.

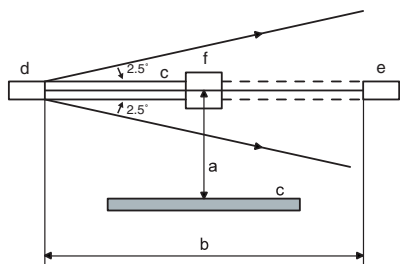

- a Distance to the reflective/mirroring surface
- b Protected field width
- c Reflective/mirroring surface
- d Transmitter
- e Receiver
- f Object

Fig. 4.2: Minimum distance to reflective surfaces

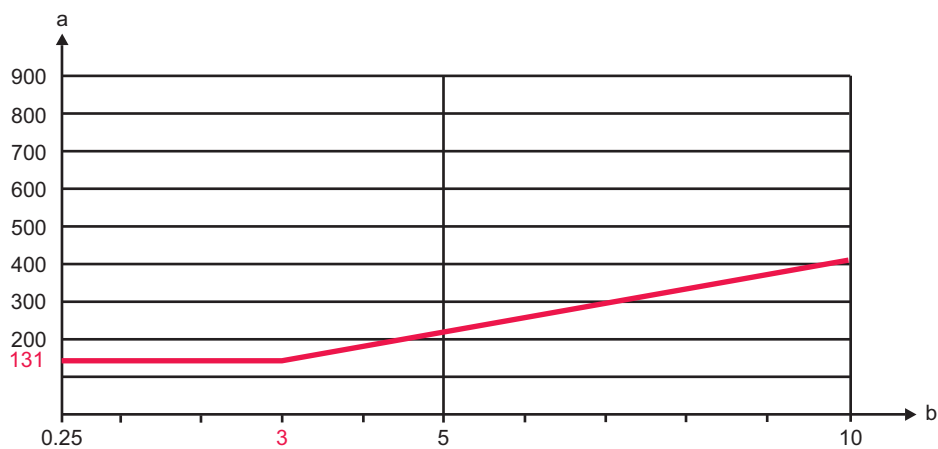

- a Required minimum distance to reflective surfaces [mm]
- b Protective field width [m]

Fig. 4.3: Minimum distance to reflective surfaces as a function of the protective field width up to 10 m

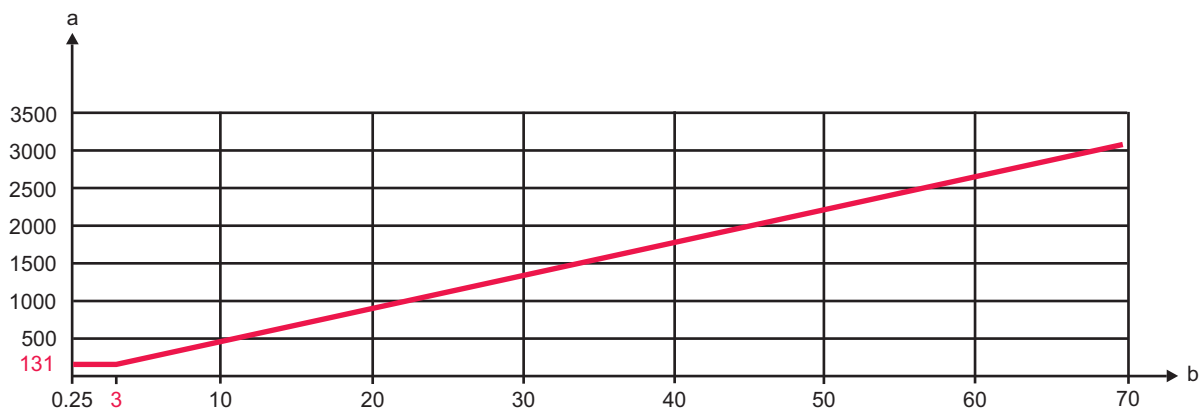

- a Required minimum distance to reflective surfaces [mm]
- b Protective field width [m]

Fig. 4.4: Minimum distance to reflective surfaces as a function of the protective field width

5 Electrical connection

 **WARNING**



Faulty electrical connection may result in serious injury!

- ↪ Only allow qualified persons (see chapter 2.2 "Competent persons") to perform the electrical connection.
- ↪ Make certain that the safety sensor is protected against overcurrent.
- ↪ For access guarding, activate the start/restart interlock and make certain that it cannot be unlocked from within the danger zone.

NOTICE



Laying cables!

- ↪ Lay all connection cables and signal lines within the electrical installation space or permanently in cable ducts.
- ↪ Lay the cables and lines so that they are protected against external damages.
- ↪ For further information: see EN ISO 13849-2, Table D.4.

5.1 Transmitter - pin assignment

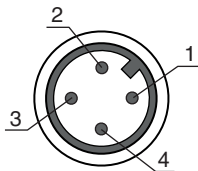

Fig. 5.1: Pin assignment transmitter

Tab. 5.1: Pin assignment transmitter

Pin	Core color	Transmitter
1	Brown	Supply voltage 19.2 V ... 28.8 V DC
2	White	NC
3	Blue	GND
4	Black	Active

5.2 Receiver - pin assignment

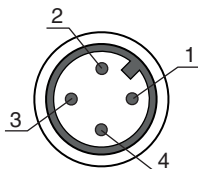



Fig. 5.2: Pin assignment receiver

Tab. 5.2: Pin assignment receiver

Pin	Core color	Receiver
1	Brown	Supply voltage 19.2 V ... 28.8 V DC
2	White	Diagnosis
3	Blue	GND
4	Black	OUT

6 Starting up the device

 WARNING	
	<p>Improper use of the safety sensor may result in serious injury!</p> <ul style="list-style-type: none">↳ Make certain that the entire device and the integration of the optoelectronic protective device were inspected by qualified and instructed persons (see chapter 2.2 "Competent persons").↳ Make certain that a dangerous process can only be started while the safety sensor is switched on.

Prerequisites:

- Safety sensor was mounted (see chapter 4 "Mounting") and connected (see chapter 5 "Electrical connection") correctly.
- Operating personnel were instructed in proper use.
- The dangerous process is switched off and the system is protected against being switched back on.



Aligning transmitter and receiver

- ↳ Connect the operating voltage to the transmitter and receiver (see chapter 5 "Electrical connection").
- ↳ Activate the transmitter via the activation input.
 - ⇒ Yellow LED and green LED on transmitter light up.
- ↳ Align the receiver with the transmitter until the yellow LED on the receiver lights up.

7 Testing

The checks should ensure that the optoelectronic protective device has been used acc. to the national/international regulations, in particular in accordance with the machine and use of work equipment directive.

7.1 Check before initial commissioning

 WARNING	
	<p>Unpredictable machine behavior during initial start-up may result in serious injury!</p> <p>↪ Make certain that there are no people in the danger zone.</p>

- ↪ Observe the nationally and internationally valid regulations.
- ↪ Ensure that the safety sensor only detects persons upon entry to the danger area and does not detect whether persons are located within the danger area.
- ↪ Before they begin work, have a competent person (see chapter 2.2 "Competent persons") train the operating personnel in their respective tasks.



Check the following criteria:

- Is the required safety distance (protective field of the safety sensor to the next point of operation) maintained?
- Is the safety sensor effective during the entire dangerous movement and in all adjustable operating modes of the machine?
- It must not be possible to climb over, climb under or circumvent the light path.
- Is a start-up/restart interlock present?

7.2 Regular testing by competent personnel

The reliable interaction of safety sensor and machine must be regularly tested by qualified persons in order to detect changes to the machine or impermissible tampering with the safety sensor.

Depending on the risk assessment, the test cycle must be defined by the integrator or operating company (e.g., daily, on shift changes, ...) or is specified by national regulations or regulations of the employer's liability insurance association and may be dependent on the machine type.

 WARNING	
	<p>Unpredictable machine behavior during the test may result in serious injury!</p> <p>↪ Make certain that there are no people in the danger zone.</p> <p>↪ Before they begin work, train the operators on their respective tasks and provide suitable test objects and an appropriate test instruction.</p>

NOTICE	
	<p>Due to complex machines and processes, it may be necessary under certain circumstances to check some points at longer time intervals.</p>

NOTICE	
	<p>For larger distances between transmitter and receiver and when using deflecting mirrors, a second person may be necessary.</p>

- Have all tests performed by competent personnel (see chapter 2.2 "Competent persons").
- Observe the nationally and internationally applicable regulations and the time periods specified therein.

Daily check of the effectiveness of the safety sensor

Examine the effectiveness of the protective field daily so that it is ensured that the protective function is active at all points e.g even with adjustments to parameters.

↪ Interrupt the light beam between the transmitter and receiver (test rod Ø 22 mm):

- In front of the transmitter and the receiver
- In the middle between the transmitter and receiver
- In front of and behind deflection mirrors

NOTICE

It must not be possible to initiate the dangerous state during beam interruption.

8 Disposal

↳ For disposal observe the applicable national regulations regarding electronic components.

9 Technical data

9.1 General specifications

Tab. 9.1: Safety-relevant technical data

Type in accordance with IEC/EN 61496-1 -2	Type 4
Performance Level (PL) in accordance with EN ISO 13849-1:2015 ¹⁾	PL e
Category in accordance with EN ISO 13849-1:2015 ¹⁾	Cat. 4
Mean time to dangerous failure (MTTF _d) in accordance with EN ISO 13849-1:2015	900 years
Mission time (T _M) in accordance with EN ISO 13849-1:2015	20 years
*): in combination with a MSI-TRM safety relay	

Tab. 9.2: Optical data

Light source	LED, modulated light; exempt group in acc. with EN 62471
Average life expectancy	100000 h at ambient temperature of 25°C
Wavelength:	
Visible red light	630 nm
Infrared light	940 nm
Typical operating range limit (maximum attainable range without function reserve)	Operating range 1: 0.25 m ... 48 m Operating range 2: 5 m ... 80 m
Operating range (recommended range with function reserve)	Operating range 1: 0.25 m ... 40 m Operating range 2: 5 m ... 70 m
Opening angle, max.	+/- 2.5 °

Tab. 9.3: Electrical data

Operating voltage U _B	24 V, DC, ±20%, including residual ripple For UL applications: only for use in "class 2" circuits in accordance with NEC.
Residual ripple	≤10% of U _B
Open-circuit current	
Transmitter	< 40 mA
Receiver	< 15 mA
Protective circuit	Polarity reversal protection Short circuit protection for all transistor outputs
Switching output/function	
Pin 2	Diagnostic output DIAG, PNP dark switching
Pin 4	Switching output OUT, PNP light switching
Signal voltage high/low	≥(U _B -2 V) / ≤2 V
Output current	Max. 100 mA

Activation input	
Switching voltage	High: ≥ 8 V, low: $\leq 1,5$ V High: min. 8 V Low: max. 1.5 V
Activation/disable delay	1 ms
Input resistance	10000 Ω , -30% ... 30%

Tab. 9.4: Timing

Switching frequency	250 Hz
Response time	2.5 ms
Readiness delay	300 ms

Tab. 9.5: Mechanical data

Housing material	Plastic, PC-PBT
Lens cover material	Plastic, PMMA
Net weight	50 g
Dimensions W x H x D	20.5 mm x 76.3 mm x 44 mm
Connection	M12 connector, 4-pin Cable, length 2 m, 4x0.21 mm ²

Tab. 9.6: Environmental data

Ambient temperature (operation)	-30 °C ... +60 °C
Storage temperature	-30 °C ... +70 °C

Tab. 9.7: Certifications

Degree of protection	IP69K, IP67
VDE protection class	III, rating voltage 50 V
Certifications	c TÜV NRTL US
Standards applied	IEC 60947-5-2, IEC/EN 61496

NOTICE



UL applications

- ↪ Certification: UL 508, C22.2 No.14-13
- ↪ Only for use in "class 2" circuits in accordance with NEC.
- ↪ These proximity switches shall be used with UL Listed Cable assemblies rated 30 V, 0.5 A min, in the field installation, or equivalent (categories: CYJV/CYJV7 or PVVA/PVVA7).

9.2 Dimensioned drawing

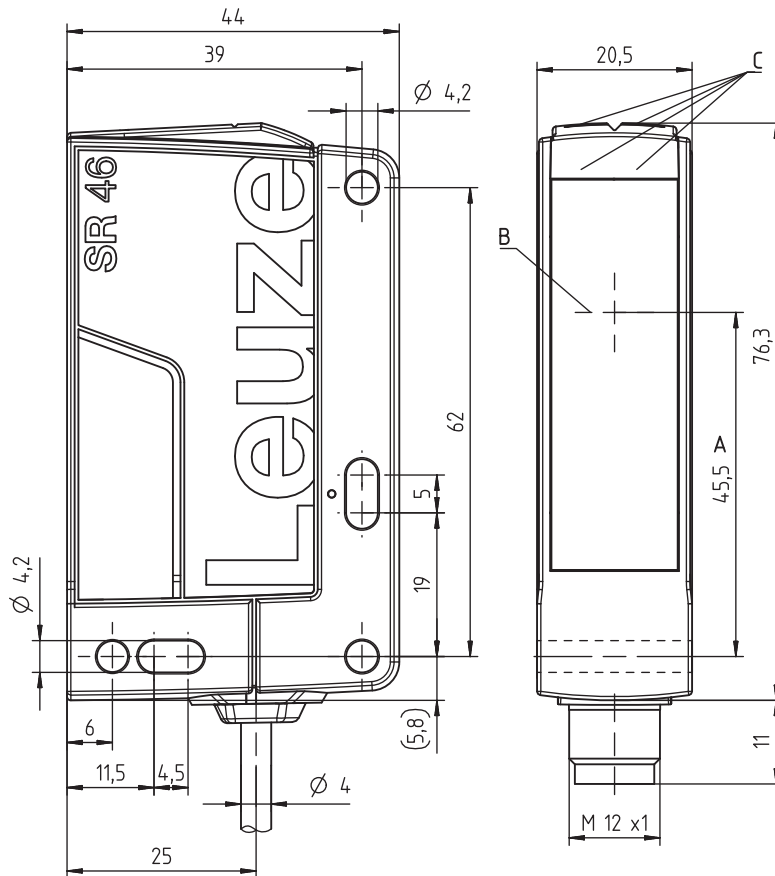

All dimensions in mm

- A Optical axis
- B Transmitter and receiver
- C Green/yellow indicator LEDs

10 Ordering information and accessories

10.1 Article list

Tab. 10.1: Ordering table

Part no.	Part designation	Device type	Description
50126545	SLS46C-40.K48	Transmitter	Operating range: 0.25 ... 40 m Operating range limit: 0.25 ... 48 m Light source: LED, red Response time: 2.5 ms Connection: cable, 2,000 mm, PUR
50126327	SLE46C-40.K4/4P	Receiver	Response time: 2.5 ms Connection: cable, 2,000 mm, PUR
50126546	SLS46C-40.K48-M12	Transmitter	Operating range: 0.25 ... 40 m Operating range limit: 0.25 ... 48 m Light source: LED, red Response time: 2.5 ms Connection: connector, M12, plastic, 4-pin
50126328	SLE46C-40.K4/4P-M12	Receiver	Response time: 2.5 ms Connection: connector, M12, plastic, 4-pin
50126547	SLS46C-70.K48	Transmitter	Operating range: 5 ... 70 m Operating range limit: 5 ... 80 m Light source: LED, red Response time: 2.5 ms Connection: cable, 2,000 mm, PUR
50126329	SLE46C-70.K4/4P	Receiver	Response time: 2.5 ms Connection: cable, 2,000 mm, PUR
50126548	SLS46C-70.K48-M12	Transmitter	Operating range: 5 ... 70 m Operating range limit: 5 ... 80 m Light source: LED, red Response time: 2.5 ms Connection: connector, M12, plastic, 4-pin
50126330	SLE46C-70.K4/4P-M12	Receiver	Response time: 2.5 ms Connection: connector, M12, plastic, 4-pin
50126549	SLS46CI-40.K48	Transmitter	Operating range: 0.25 ... 40 m Operating range limit: 0.25 ... 48 m Light source: LED, infrared Response time: 2.5 ms Connection: cable, 2,000 mm, PUR
50126331	SLE46CI-40.K4/4P	Receiver	Response time: 2.5 ms Connection: cable, 2,000 mm, PUR
50126550	SLS46CI-40.K48-M12	Transmitter	Operating range: 0.25 ... 40 m Operating range limit: 0.25 ... 48 m Light source: LED, infrared Response time: 2.5 ms Connection: connector, M12, plastic, 4-pin
50126332	SLE46CI-40.K4/4P-M12	Receiver	Response time: 2.5 ms Connection: connector, M12, plastic, 4-pin

Part no.	Part designation	Device type	Description
50126551	SLS46CI-70.K48	Transmitter	Operating range: 5 ... 70 m Operating range limit: 5 ... 80 m Light source: LED, infrared Response time: 2.5 ms Connection: cable, 2,000 mm, PUR
50126333	SLE46CI-70.K4/4P	Receiver	Response time: 2.5 ms Connection: cable, 2,000 mm, PUR
50126552	SLS46CI-70.K48-M12	Transmitter	Operating range: 5 ... 70 m Operating range limit: 5 ... 80 m Light source: LED, infrared Response time: 2.5 ms Connection: connector, M12, plastic, 4-pin
50126334	SLE46CI-70.K4/4P-M12	Receiver	Response time: 2.5 ms Connection: connector, M12, plastic, 4-pin

10.2 Accessories

Tab. 10.2: Accessories - mounting technology

Part no.	Part designation	Description
50105315	BT46	Mounting device; L-shaped bracket
50117253	BTU 300M-D10	Mounting system for 10 mm rod
50117252	BTU 300M-D12	Mounting system for 12 mm rod
50117251	BTU 300M-D14	Mounting system for 14 mm rod
50120425	BTU 300M.5-D12	Mounting system for 12 mm rod, stainless steel
50122797	BTU 346M-D12	Mounting system for 12 mm rod
50122798	BTU 346M.5-D12	Mounting system for 12 mm rod, stainless steel
50119332	BTU 900M-D10	Mounting system for 10 mm rod
50119331	BTU 900M-D12	Mounting system for 12 mm rod
50119330	BTU 900M-D14	Mounting system for 14 mm rod

Tab. 10.3: Accessories - M12 cable sockets

Part no.	Part designation	Description
50031323	KD 095-4A	Cable socket, M12, A-coded, axial, 4-pin
50031324	KD 095-4	Cable socket, M12, A-coded, angled, 4-pin

Tab. 10.4: Accessories – connection cables

Part no.	Part designation	Description
50123532	K-D M12A-4P-30m-PVC	Connection 1: connector, M12, axial, female, A-coded, 4-pin Connection 2: open cable end Shielded: no Cable length: 30,000 mm Material sheathing: PVC

Part no.	Part designation	Description
50130654	KD U-M12-4A-P1-020	Connection 1: connector, M12, axial, female, A-coded, 4-pin Connection 2: open cable end Shielded: no Cable length: 2,000 mm Material sheathing: PUR
50130657	KD U-M12-4A-P1-050	Connection 1: connector, M12, axial, female, A-coded, 4-pin Connection 2: open cable end Shielded: no Cable length: 5,000 mm Material sheathing: PUR
50130658	KD U-M12-4A-P1-100	Connection 1: connector, M12, axial, female, A-coded, 4-pin Connection 2: open cable end Shielded: no Cable length: 10,000 mm Material sheathing: PUR
50130648	KD U-M12-4A-V1-020	Connection 1: connector, M12, axial, female, A-coded, 4-pin Connection 2: open cable end Shielded: no Cable length: 2,000 mm Material sheathing: PVC
50130652	KD U-M12-4A-V1-050	Connection 1: connector, M12, axial, female, A-coded, 4-pin Connection 2: open cable end Shielded: no Cable length: 5,000 mm Material sheathing: PVC
50130653	KD U-M12-4A-V1-100	Connection 1: connector, M12, axial, female, A-coded, 4-pin Connection 2: open cable end Shielded: no Cable length: 10,000 mm Material sheathing: PVC
50132431	KD U-M12-4A-V1-200	Connection 1: connector, M12, axial, female, A-coded, 4-pin Connection 2: open cable end Shielded: no Cable length: 20,000 mm Material sheathing: PVC

Part no.	Part designation	Description
50130692	KD U-M12-4W-P1-020	Connection 1: Connector, M12, angled, female, A-coded, 4-pin Connection 2: open cable end Shielded: no Cable length: 2,000 mm Material sheathing: PUR
50130694	KD U-M12-4W-P1-050	Connection 1: connector, M12, angled, female, A-coded, 4-pin Connection 2: open cable end Shielded: no Cable length: 5,000 mm Material sheathing: PUR
50130695	KD U-M12-4W-P1-100	Connection 1: Connector, M12, angled, female, A-coded, 4-pin Connection 2: open cable end Shielded: no Cable length: 10,000 mm Material sheathing: PUR
50130688	KD U-M12-4W-V1-020	Connection 1: Connector, M12, angled, female, A-coded, 4-pin Connection 2: open cable end Shielded: no Cable length: 2,000 mm Material sheathing: PVC
50130690	KD U-M12-4W-V1-050	Connection 1: Connector, M12, angled, female, A-coded, 4-pin Connection 2: open cable end Shielded: no Cable length: 5,000 mm Material sheathing: PVC
50130691	KD U-M12-4W-V1-100	Connection 1: Connector, M12, angled, female, A-coded, 4-pin Connection 2: open cable end Shielded: no Cable length: 10,000 mm Material sheathing: PVC
50132641	KD U-M12-4W-V1-200	Connection 1: Connector, M12, angled, female, A-coded, 4-pin Connection 2: open cable end Shielded: no Cable length: 20,000 mm Material sheathing: PVC

Tab. 10.5: Safety relays

Part no.	Part designation	Description
547931	MSI-TRMB-01	Safety relay
547932	MSI-TRMB-02	Safety relay

Tab. 10.6: Alignment aid

Part no.	Part designation	Description
50109545	Sensor scope SAT 5	Alignment control

11 EC Declaration of Conformity



the **sensor** people

**EG-KONFORMITÄTS-
ERKLÄRUNG**

**EC DECLARATION
OF CONFORMITY**

**DECLARATION CE
DE CONFORMITE**

Hersteller:

Manufacturer:

Constructeur:

Leuze electronic GmbH + Co. KG
In der Braike 1, PO Box 1111
73277 Owen, Germany

Produktbeschreibung:

Description of product:

Description de produit:

**Einweg-Sicherheits-
Lichtschranke, Berührungslos
wirkende Schutzeinrichtung,
Sicherheitsbauteil nach
2006/42/EG
Anhang IV
SLS 46C (Type 4)
Seriennummer siehe Typschild**

**Protective troughbeam
photoelectric sensor, Active
opto-electronic protective
device, safety component in
acc. with
2006/42/EC
annex IV
SLS 46C (Type 4)
Serial no. see name plates**

**Barrière unidirectionelle,
Équipement de protection
électro-sensible, Élement de
sécurité selon
2006/42/CE
annexe IV
SLS 46C (Type 4)
N° série voir plaques
signalétiques**

Die alleinige Verantwortung
für die Ausstellung dieser
Konformitätserklärung trägt
der Hersteller.

This declaration of conformity
is issued under the sole
responsibility of the
manufacturer.

La présente déclaration de
conformité est établie sous la
seule responsabilité du
fabricant.

Der oben beschriebene
Gegenstand der Erklärung
erfüllt die einschlägigen
Harmonisierungsrechts-
vorschriften der Union:

The object of the declaration
described above is in
conformity with the relevant
Union harmonisation
legislation:

L'objet de la déclaration décrit
ci-dessus est conforme à la
législation d'harmonisation de
l'Union applicable:

Angewandte EG-Richtlinie(n):

Applied EC Directive(s):

Directive(s) CE appliquées:

**2006/42/EG
2014/30/EU**

**2006/42/EC
2014/30/EU**

**2006/42/CE
2014/30/UE**

Angewandte harmonisierte Normen / Applied harmonized standards / Normes harmonisées appliquées :

**EN 61496-1: 2013 (*1)
EN 60204-1: 2006+A1:2009
+AC:2010**

**IEC 61496-2: 2013 (*1)
EN 60947-5-2: 2007+A1:2012**

**EN ISO 13849-1:2015 (Kat 4, PLe)
(*1)
EN 61000-6-3: 2007+A1:2011
+AC:2012**

Angewandte technische Spezifikationen / Applied technical specifications / Spécifications techniques
appliquées :

Notified Body

(*1) TÜV-SÜD PRODUCT SERVICE GmbH Zertifizierungsstelle Ridlerstraße 65 D-80339 München NB 0123

Dokumentationsbevollmächtigter ist der genannte Hersteller, Kontakt: quality@leuze.de.
Authorized for documentation is the stated manufacturer, contact: quality@leuze.de.

Autorisé pour documentation est le constructeur déclaré, contact: quality@leuze.de

2014/30/EU veröffentlicht: 29.03.2014, EU-Amtsblatt Nr. L 96/79-106; 2014/30/EU published: 29.03.2014, EU-Journal No. L 96/79-106; 2014/30/UE publié: Journal EU n° L 96/79-106

7.10.2016
Datum / Date / Date **Ulrich Balbach, Geschäftsführer / Managing Director / Gérant**

Leuze electronic GmbH + Co. KG
In der Braike 1
D-73277 Owen
Telefon +49 (0) 7021 573-0
Telefax +49 (0) 7021 573-199
info@leuze.de
www.leuze.com

LEO-ZQM-148-06-FO

Leuze electronic GmbH + Co. KG, Sitz Owen, Registergericht Stuttgart, HRA 230712
Persönlich haftende Gesellschafterin Leuze electronic Geschäftsführungs-GmbH,
Sitz Owen, Registergericht Stuttgart, HRB 230550

Geschäftsführer: Ulrich Balbach
US: idN: DE 145912521 | Zollnummer: 2554232

Es gelten ausschließlich unsere aktuellen Verkaufs- und Lieferbedingungen
Only our current Terms and Conditions of Sale and Delivery shall apply

