

Original operating instructions

AMS 335i

Optical Laser Measurement System – CANopen



© 2023

Leuze electronic GmbH + Co. KG

In der Braike 1

D-73277 Owen / Germany

Phone: +49 7021 573-0

Fax: +49 7021 573-199

<http://www.leuze.com>

info@leuze.de

The main menus

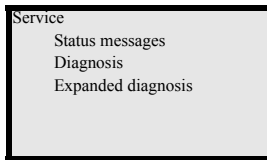
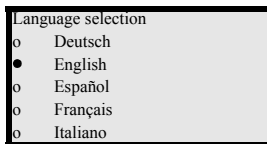
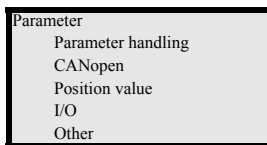
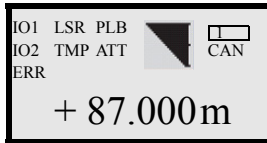
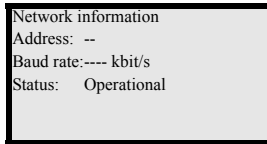
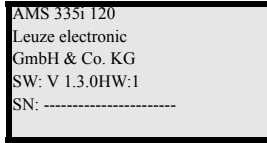

Device information - main menu

This menu item contains detailed information on

- Device type
- Manufacturer
- Software and hardware version
- Serial number

No entries can be made via the display.

Network information - main menu

Explanations of address, baud rate, status. No entries can be made via the display.

Status and measurement data - main menu

- Display of status, warning and error messages.
- Status overview of the switching inputs/ outputs
- Bar graph for the received signal level.
- Activated interface.
- Measurement value

No entries can be made via the display. See "Indicators in the display" on page 40.

Parameter - main menu

- Configuration of the AMS.

See "Parameter menu" on page 45.

Language selection - main menu

- Selection of the display language.

See "Language selection menu" on page 50.

Service - main menu

- Display of status messages.
- Display of diagnostic data.

No entries can be made via the display. See "Service menu" on page 50.

Device buttons:

- Navigate upward/sideways
- Navigate downward/sideways
- ESCAPE** leave
- ENTER** confirm

Input of values

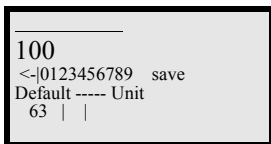

- + **Delete character**
- + **Enter digit**
- save** + **Save input**

- 1 General information 5**
- 1.1 Explanation of symbols 5
- 1.2 Declaration of Conformity 5
- 1.3 Description of functions AMS 335/ 6

- 2 Safety 7**
- 2.1 Intended use 7
- 2.2 Foreseeable misuse 8
- 2.3 Competent persons 8
- 2.4 Exemption of liability 9
- 2.5 Laser safety notices 9

- 3 Fast commissioning / operating principle 12**
- 3.1 Mounting the AMS 335/ 12
- 3.1.1 Mounting the device 12
- 3.1.2 Mounting the reflector 12
- 3.2 Connecting the voltage supply 13
- 3.3 Display 13
- 3.4 AMS 335/ on the CANopen 13

- 4 Technical data 14**
- 4.1 Technical data of laser measurement system 14
- 4.1.1 General specifications AMS 335/ 14
- 4.1.2 AMS 335/ dimensioned drawing 16
- 4.1.3 Overview of AMS 335/ types 17

- 5 Installation and mounting 18**
- 5.1 Storage, transportation 18
- 5.2 Mounting the AMS 335/ 19
- 5.2.1 Optional mounting bracket 21
- 5.2.2 Parallel mounting of the AMS 335/ 22
- 5.2.3 Parallel mounting of AMS 335/ and DDLS optical data transmission 23
- 5.3 Mounting the AMS 335/ with laser beam deflector unit 24
- 5.3.1 Mounting the laser beam deflector unit with integrated mounting bracket 24
- 5.3.2 Dimensioned drawing of US AMS 01 deflector unit 25
- 5.3.3 Mounting the US 1 OMS deflector unit without mounting bracket 26

6	Reflectors	27
6.1	General information	27
6.2	Description of the reflective tape	27
6.2.1	Technical data of self-adhesive tape	28
6.2.2	Technical data of reflective tape on carrier plate	28
6.2.3	Dimensioned drawing of reflective tape on carrier plate	29
6.2.4	Technical data of heated reflectors	30
6.2.5	Dimensioned drawing of heated reflectors	31
6.3	Selecting reflector size	32
6.4	Mounting the reflector	33
6.4.1	General information	33
6.4.2	Mounting the reflector	33
6.4.3	Table of reflector pitches	36
7	Electrical connection	37
7.1	Safety notices for the electrical connection	37
7.2	PWR – voltage supply / switching input/output	38
7.3	CANopen BUS IN	38
7.4	CANopen BUS OUT	39
7.5	Service	39
8	Display and control panel AMS 335/	40
8.1	Structure of the control panel	40
8.2	Status indicators and operation	40
8.2.1	Indicators in the display	40
8.2.2	LED status indicators	42
8.2.3	Control buttons	43
8.3	Menu description	44
8.3.1	The main menu	44
8.3.2	Parameter menu	45
8.3.3	Language selection menu	50
8.3.4	Service menu	50
8.4	Operation	51
9	CANopen interface	53
9.1	General information on CANopen	53
9.1.1	Topology	53
9.1.2	Bus line (trunk line)	53

- 9.1.3 Stub cables (drop lines) 54
- 9.2 Address assignment 55
 - 9.2.1 Entering the address via the display 55
- 9.3 Baud rate setting 56
 - 9.3.1 Entering baud rate via display/panel 56
- 9.4 CANopen electrical connection 57
- 9.5 Communication mechanisms of AMS 335*i* on CAN 58
 - 9.5.1 Device profile of AMS 335*i* 58
 - 9.5.2 Object directories 58
 - 9.5.3 EDS file 59
 - 9.5.4 SDOs and PDOs 59
 - 9.5.5 Default 11 bit identifier 61
 - 9.5.6 Object structure of AMS 335*i* 62
 - 9.5.7 Detailed description of CANopen-specific object area 63
 - 9.5.8 AMS 335*i*-specific object area 69
 - 9.5.9 Objects of AMS 335*i* from encoder profile DS406 Class 1 87
- 10 Diagnostics and troubleshooting 90**
 - 10.1 Service and diagnosis in the display of the AMS 335*i* 90
 - 10.1.1 Status messages 90
 - 10.1.2 Diagnosis 91
 - 10.1.3 Expanded diagnosis 91
 - 10.2 General causes of errors 92
 - 10.2.1 Power LED 92
 - 10.3 Interface errors 93
 - 10.3.1 NET LED 93
 - 10.4 Status indicators in the display of the AMS 335*i* 93
- 11 Type overview and accessories 95**
 - 11.1 Part number code 95
 - 11.1.1 Type overview AMS 335*i* (CANopen) 95
 - 11.2 Overview of reflector types 96
 - 11.3 Accessories 96
 - 11.3.1 Accessories – Mounting bracket 96
 - 11.3.2 Accessories – Deflector unit 96
 - 11.3.3 Accessories – M12 connector 96
 - 11.3.4 Accessories – Terminating resistor 97
 - 11.3.5 Accessories – Ready-made cables for voltage supply 97
 - 11.3.6 Accessory ready-made cables for CANopen 98

12	Maintenance	100
12.1	General maintenance information	100
12.2	Repairs, servicing	100
12.3	Disassembling, packing, disposing	100

1 General information

1.1 Explanation of symbols

The symbols used in this technical description are explained below.



Attention!

This symbol precedes text messages which must strictly be observed. Failure to observe the provided instructions could lead to personal injury or damage to equipment.



Attention Laser!

This symbol warns of possible danger through hazardous laser radiation.



Note!

This symbol indicates text passages containing important information.

1.2 Declaration of Conformity

The AMS 335*i* absolute measuring optical laser measurement system was designed and manufactured in accordance with the applicable European directives and standards.

The AMS series is "UL LISTED" according to American and Canadian safety standards and fulfills the requirements of Underwriter Laboratories Inc. (UL).



Note!

The Declaration of Conformity for these devices can be requested from the manufacturer.

The manufacturer of the product, Leuze electronic GmbH & Co. KG in D-73277 Owen, possesses a certified quality assurance system in accordance with ISO 9001.

1.3 Description of functions AMS 335*i*

The AMS 335*i* optical laser measurement system calculates distances to fixed as well as moving system parts. The distance to be measured is calculated according to the principle of the propagation time of radiated light. Here, the light emitted by the laser diode is reflected by a reflector onto the receiving element of the laser measurement system. The AMS 335*i* uses the "propagation time" of the light to calculate the distance to the reflector. The high absolute measurement accuracy of the laser measurement system and the fast response time are designed for position control applications.

With its AMS 3xx*i* product series, Leuze makes available a wide range of internationally relevant interfaces. Note that each interface version listed below corresponds to a different AMS 3xx*i* model.



AMS 304*i*



AMS 348*i*



AMS 355*i*



AMS 358*i*



AMS 335*i*



AMS 338*i*



AMS 308*i*



AMS 384*i*



AMS 301*i*



AMS 300*i*

2 Safety

This sensor was developed, manufactured and tested in line with the applicable safety standards. It corresponds to the state of the art.

2.1 Intended use

The AMS is an absolute measuring optical laser measurement system which allows distance measurement of up to 300m against a reflector.

Areas of application

The AMS is designed for the following areas of application:

- Positioning of automated, moving plant components
- Travel and lifting axes of high-bay storage devices
- Repositioning units
- Gantry crane bridges and their trolleys
- Elevators
- Electroplating plants

 CAUTION
Observe intended use! ⌘ <i>Only operate the device in accordance with its intended use. The protection of personnel and the device cannot be guaranteed if the device is operated in a manner not complying with its intended use.</i> <i>Leuze electronic GmbH + Co. KG is not liable for damages caused by improper use.</i> ⌘ <i>Read the technical description before commissioning the device. Knowledge of this technical description is an element of proper use.</i>

NOTE
Comply with conditions and regulations! ⌘ <i>Observe the locally applicable legal regulations and the rules of the employer's liability insurance association.</i>



Attention

For UL applications, use is only permitted in Class 2 circuits in accordance with the NEC (National Electric Code).

2.2 Foreseeable misuse

Any use other than that defined under "Intended use" or which goes beyond that use is considered improper use.

In particular, use of the device is not permitted in the following cases:

- in rooms with explosive atmospheres
- as stand-alone safety component in accordance with the machinery directive ¹⁾
- for medical purposes

NOTE

Do not modify or otherwise interfere with the device!

⚠ *Do not carry out modifications or otherwise interfere with the device.*

The device must not be tampered with and must not be changed in any way.

The device must not be opened. There are no user-serviceable parts inside.

Repairs must only be performed by Leuze electronic GmbH + Co. KG.

2.3 Competent persons

Connection, mounting, commissioning and adjustment of the device must only be carried out by competent persons.

Prerequisites for competent persons:

- They have a suitable technical education.
- They are familiar with the rules and regulations for occupational safety and safety at work.
- They are familiar with the technical description of the device.
- They have been instructed by the responsible person on the mounting and operation of the device.

Certified electricians

Electrical work must be carried out by a certified electrician.

Due to their technical training, knowledge and experience as well as their familiarity with relevant standards and regulations, certified electricians are able to perform work on electrical systems and independently detect possible dangers.

In Germany, certified electricians must fulfill the requirements of accident-prevention regulations DGUV (German Social Accident Insurance) provision 3 (e.g. electrician foreman). In other countries, there are respective regulations that must be observed.

¹⁾ Use as safety-related component within the safety function is possible, if the component combination is designed correspondingly by the machine manufacturer.

2.4 Exemption of liability

Leuze electronic GmbH + Co. KG is not liable in the following cases:

- The device is not being used properly.
- Reasonably foreseeable misuse is not taken into account.
- Mounting and electrical connection are not properly performed.
- Changes (e.g., constructional) are made to the device.

2.5 Laser safety notices



ATTENTION! LASER RADIATION – CLASS 2 LASER PRODUCT

Do not stare into beam!

The device satisfies the requirements of IEC 60825-1:2014 / EN 60825-1:2014+A11:2021 safety regulations for a product of **laser class 2** and complies with 21 CFR 1040.10 except for conformance with IEC 60825-1 Ed. 3., as described in Laser Notice No. 56, dated May 8, 2019.

- ⚠ *Never look directly into the laser beam or in the direction of reflected laser beams!
If you look into the beam path over a longer time period, there is a risk of injury to the retina.*
- ⚠ *Do not point the laser beam of the device at persons!*
- ⚠ *Interrupt the laser beam using a non-transparent, non-reflective object if the laser beam is accidentally directed towards a person.*
- ⚠ *When mounting and aligning the device, avoid reflections of the laser beam off reflective surfaces!*
- ⚠ *CAUTION! The use of operating and adjustment devices other than those specified here or the carrying out of differing procedures may lead to dangerous exposure to radiation.*
- ⚠ *Observe the applicable statutory and local laser protection regulations.*
- ⚠ *The device must not be tampered with and must not be changed in any way.
There are no user-serviceable parts inside the device.
Repairs must only be performed by Leuze electronic GmbH + Co. KG.*

NOTE**Affix laser information and warning signs!**

Laser information and warning signs are attached to the device (see figure 2.1). Also included with the device are self-adhesive laser warning and laser information signs (stick-on labels) in multiple languages (see figure 2.2).

↪ *Affix the laser information sheet to the device in the language appropriate for the place of use.*

When using the device in the U.S.A., use the stick-on label with the "Complies with 21 CFR 1040.10" notice.

↪ *Affix the laser information and warning signs near the device if no signs are attached to the device (e.g. because the device is too small) or if the attached laser information and warning signs are concealed due to the installation position.*

Affix the laser information and warning signs so that they can be read without the reader being exposed to the laser radiation of the device or other optical radiation.

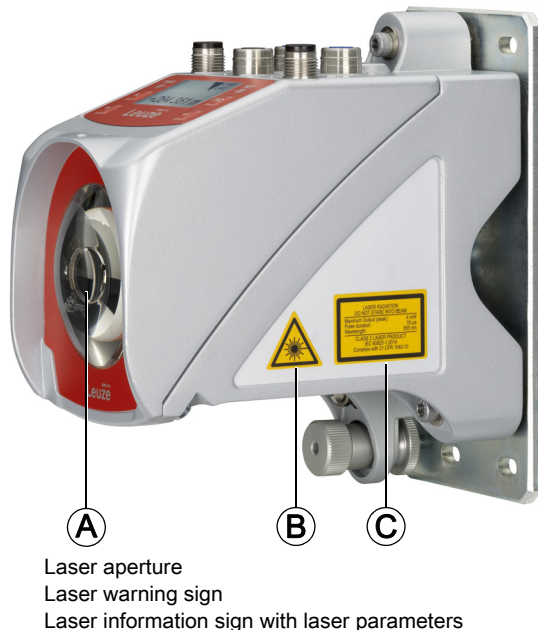

Figure 2.1: Laser apertures, laser warning signs

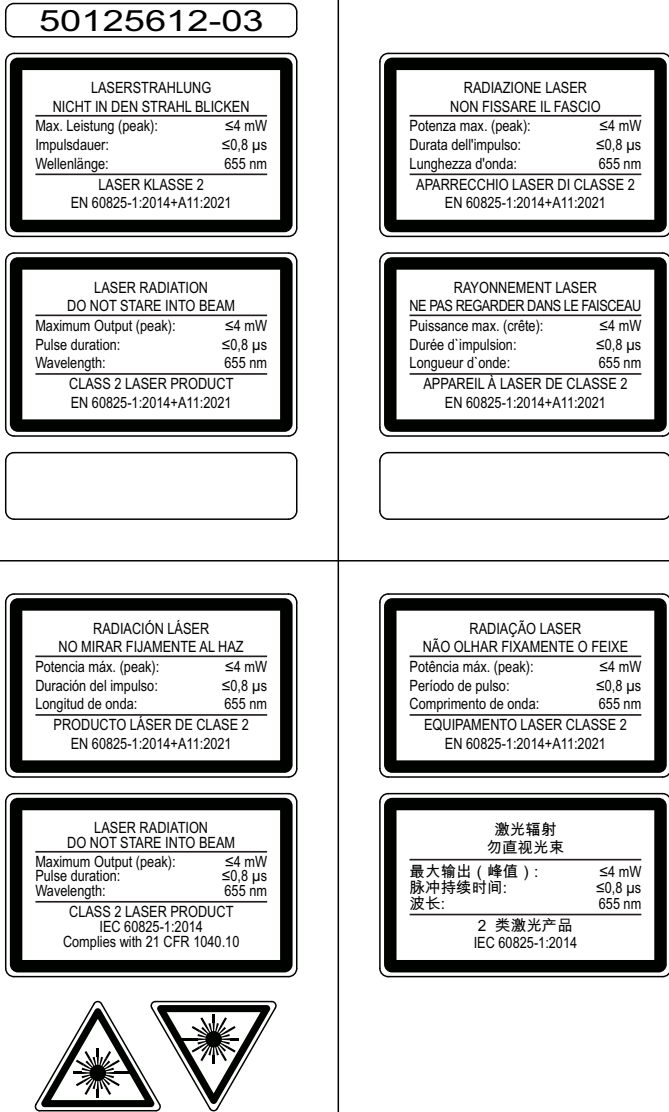

Figure 2.2: Laser warning and information signs – supplied stick-on labels

3 Fast commissioning / operating principle

**Note!**

Below you will find a **short description for the initial commissioning** of the AMS 335*i*. Detailed explanations for the listed points can be found throughout the handbook.

3.1 Mounting the AMS 335*i*

The AMS 335*i* and the corresponding reflector are mounted on two mutually opposing, plane-parallel, flat walls.



Figure 3.1: Schematic illustration of mounting

**Attention!**

For error-free position measurement, there must be an unobstructed line-of-sight between the AMS 335*i* and the reflector.

3.1.1 Mounting the device

The laser is mounted using 4 screws (M5).

Alignment is performed using 2 adjustment screws. Adjust so that the laser light spot is positioned at the center of the reflector. The alignment is secured with the knurled nut and locked with the M5 nut.

Detailed information can be found in Chapter 5.2 and Chapter 5.3.

3.1.2 Mounting the reflector

The reflector is mounted using 4 screws (M5). The reflector is angled using the spacer sleeves included. Incline the reflector by approx. 1°.

Detailed information can be found in Chapter 6.4.

3.2 Connecting the voltage supply

The laser measurement system is connected using M12 connectors. The voltage supply is connected via the PWR M12 connection.

Detailed information can be found in Chapter 7.

3.3 Display

Once the laser measurement system is supplied with voltage, the device status as well as the measured position values can be read on the display. The display automatically switches to the display of the measurement values.

Use the up/down buttons (▲ ▼) to the left of the display to read and change a wide range of data and parameters.

Depending on the connected interface, the network address must be configured via the display.

Detailed information can be found in Chapter 8.

3.4 AMS 335*i* on the CANopen

Install the EDS file that belongs to the AMS 335*i*..., in your planning tool/control (e.g. TwinCAT).



Note!

You can find the EDS file at www.leuze.com.

The AMS 335*i* is configured in the planning tool/control by means of the EDS file. If the AMS 335*i* has been assigned an address in the planning tool, the address (Node ID) must be set on the AMS 335*i* via the control panel/display. Only if the addresses are the same between the AMS 335*i* and the control can communication be established.

After all parameters have been set in the planning tool/control, the download to the AMS 335*i* takes place. The set parameters are now stored on the AMS 335*i*.

All changed AMS 335*i* parameters should then be stored in the start-up of the control. This helps in retaining the parameters during device exchanges because the parameters are now also stored centrally in the control.

Each time a connection is established between the control and the AMS 335*i*, these parameters are now transmitted again to the AMS 335*i*. Note that this function must be supported by the control.

The CANopen baud rate is defined for the entire network in the planning tool/control.

On the AMS 335*i*, the baud rate is set via the control panel/display.

Communication with the AMS 335*i* is only possible if the baud rates match.

Detailed information can be found in Chapter 9.

4 Technical data

4.1 Technical data of laser measurement system

4.1.1 General specifications AMS 335/

Measurement data	AMS 335/40 (H)	AMS 335/120 (H)	AMS 335/200 (H)	AMS 335/300 (H)
Measurement range	0.2 ... 40m	0.2 ... 120m	0.2 ... 200m	0.2 ... 300m
Accuracy	± 2mm	± 2mm	± 3mm	± 5mm
Reproducibility ¹⁾	0.3mm	0.5mm	0.7mm	1.0mm
Light spot diameter	≤ 40mm	≤ 100mm	≤ 150mm	≤ 225mm
Output time			1.7 ms	
Response time			14ms	
Basis for contouring error calculation			7ms	
Resolution	Adjustable; see chapters on individual interfaces			
Temperature drift			≤ 0.1 mm/K	
Ambient temperature sensitivity			1 ppm/K	
Air pressure sensitivity			0.3ppm/hPa	
Traverse rate			≤ 10m/s	
Electrical data				
Supply voltage V_{in} ²⁾			18 ... 30VDC	
Current consumption			Without device heating: ≤ 250mA / 24VDC With device heating: ≤ 500mA / 24VDC	
Optical data				
Transmitter			Laser diode, red light	
Laser class	2 in acc. with IEC 60825-1:2014 / EN 60825-1:2014+A11:2021			
Wavelength			655nm	
Impulse duration			≤ 0.8µs	
Max. output power (peak)			≤ 4mW	
Interfaces				
CANopen (baud rate in kbit/s)	20 / 50 / 125 (default) / 250 / 500 / 800 / 1000			
Vendor ID	0x121 _H or 289 _{Dec}			
Device type	0x00080196 (absolute linear encoder)			
Controls and indicators				
Keyboard			4 keys	
Display	Monochromatic graphical display, 128 x 64 pixels			
LED	2 LEDs, two-colored			
Inputs/outputs				
Quantity	2, programmable			
Input	Protected against polarity reversal			
Output	Max. 60 mA, short-circuit-proof			

Mechanical data

Housing	Diecast zinc/aluminum
Optics	Glass
Weight	Approx. 2.45 kg
Degree of protection	IP 65 acc. to EN 60529 ³⁾

Environmental conditions

Operating temperature	
without device heating	-5 °C ... +50 °C
with device heating	-30 °C ... +50 °C ⁴⁾
Storage temperature	-30 °C ... +70 °C
Air humidity	Max. 90% rel. humidity, non-condensing
MTTF	31 years (at 25 °C) ⁵⁾

Mechanical/electrical loading capacity

Vibration	Acc. to EN 60068-2-6
Noise	Acc. to EN 60060-2-64
Shock	Acc. to EN 60068-2-27
EMC	Acc. to EN 61000-6-2 and EN 61000-6-4 ⁶⁾

- 1) Statistical error: 1 sigma; minimum switch-on time: 2 min.
- 2) For UL applications: only for use in "Class 2" circuits according to NEC.
- 3) With screwed-on M12 connectors or mounted caps.
- 4) With devices with heating, the switch on/off area of the internal heating can be extended to prevent condensation from forming. Total prevention of condensation cannot be guaranteed due to the limited heating capacity of the AMS 335*i*.
- 5) We reserve the right to make changes. (Value is updated at regular intervals.)
- 6) This is a Class A product. In a domestic environment this product may cause radio interference, in which case the operator may be required to take adequate measures.



The AMS 335*i* is designed in accordance with protection class III for supply with PELV (protective extra-low voltage).

4.1.2 AMS 335/*i* dimensioned drawing

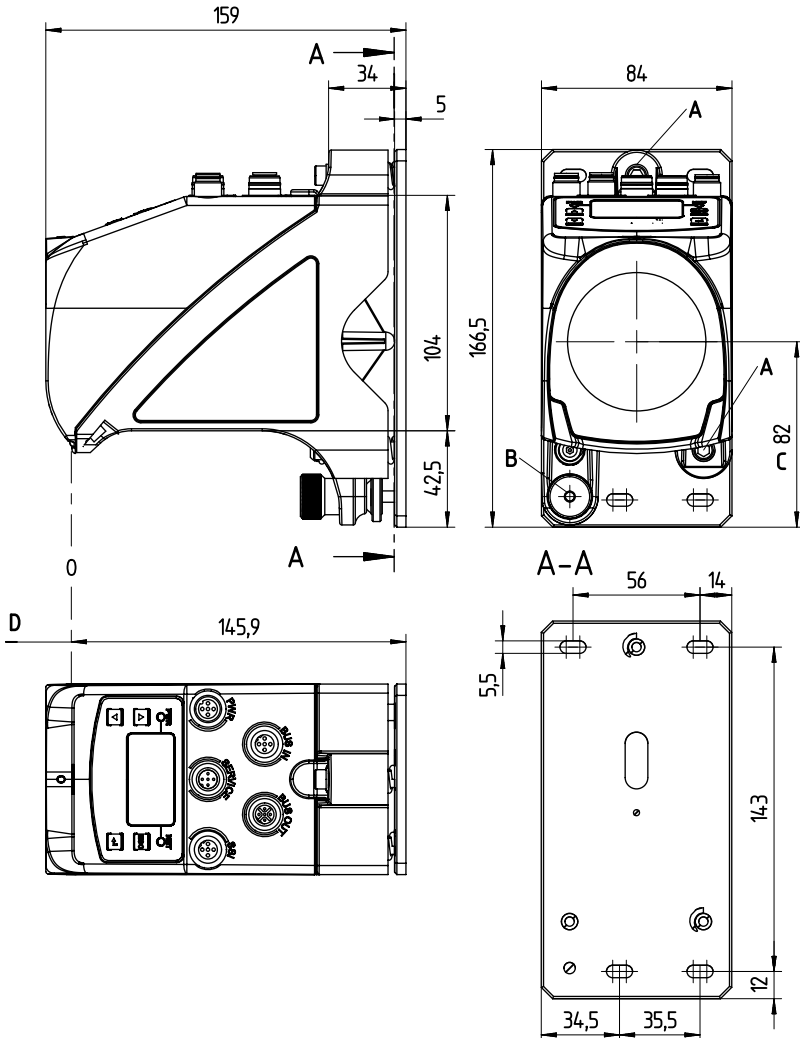

- A M 5 screw for alignment
- B Knurled nut with WAF4 hexagon socket and M5 nut for securing
- C Optical axis
- D Zero point of the distance to be measured

Figure 4.1: AMS 335/*i* dimensioned drawing

4.1.3 Overview of AMS 335/i types

AMS 335/(CANopen)

Type designation	Description	Part no.
AMS 335/40	40m operating range, CANopen interface	50113693
AMS 335/120	120m operating range, CANopen interface	50113694
AMS 335/200	200m operating range, CANopen interface	50113695
AMS 335/300	300m operating range, CANopen interface	50113696
AMS 335/40 H	40m operating range, CANopen interface, integrated heating	50113697
AMS 335/120 H	120m operating range, CANopen interface, integrated heating	50113698
AMS 335/200 H	200m operating range, CANopen interface, integrated heating	50113699
AMS 335/300 H	300m operating range, CANopen interface, integrated heating	50113700

Table 4.1: Overview of AMS 335/i types

5 Installation and mounting

5.1 Storage, transportation



Attention!

Package the device for transport and storage in such a way that is protected against shock and humidity. Optimum protection is achieved when using the original packaging. Ensure compliance with the approved environmental conditions listed in the specifications.

Unpacking

- ↳ Check the packaging content for any damage. If damage is found, notify the post office or shipping agent as well as the supplier.
- ↳ Check the delivery contents using your order and the delivery papers:
 - Delivered quantity
 - Device type and model as indicated on the name plate
 - Brief manual

The name plate provides information as to what AMS 335*i* type your device is. For specific information, please refer to Chapter 11.1.1.

Name plates



Figure 5.1: Device name plate using the AMS 358*i* as an example



Note!

Please note that the shown name plate is for illustration purposes only; the contents do not correspond to the original.

- ↳ Save the original packaging for later storage or shipping.

If you have any questions concerning your shipment, please contact your supplier or your local Leuze sales office.

↳ *Observe the applicable local regulations when disposing of the packaging materials.*

5.2 Mounting the AMS 335*i*

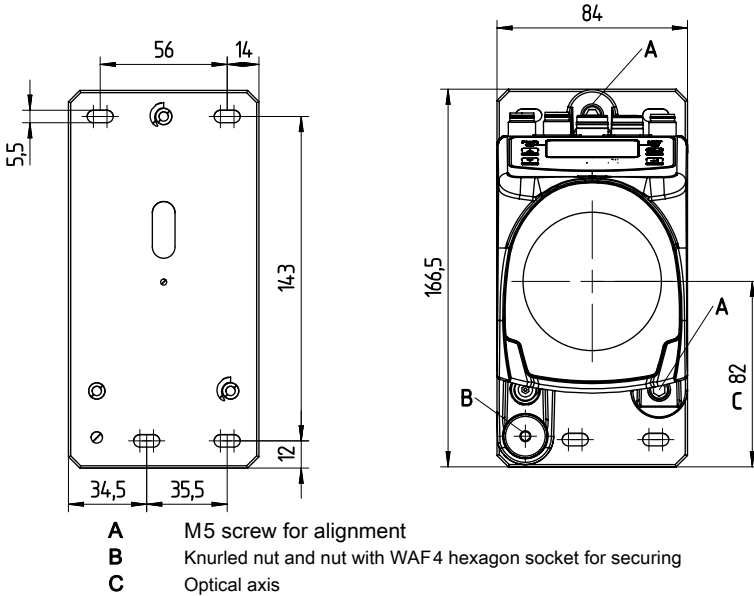

Figure 5.2: Mounting the device

The AMS 335*i* and the corresponding reflector are mounted on two mutually opposing, plane-parallel, flat walls or system parts. For error-free position measurement, there must be an unobstructed line-of-sight between the AMS 335*i* and the reflector.

Use M5 screws to fasten the laser measurement system. Secure the screws with a lock washer to protect against loosening caused by vibrations.

Aligning the laser light spot with the center of the reflector

The laser light spot has to be aligned so that it always hits the center of the opposing reflector, both at close range as well as at the maximum measurement distance. **To align, use the two M5 Allen screws ("A" in Figure 5.2).** When aligning, please ensure that the knurled nut and the lock nut ("B" in Figure 5.2) are opened wide.

**Attention!**

To prevent the laser measurement system from moving out of alignment during continuous operation, subsequently hand-tighten the knurled nut and counterlock with the nut with WAF4 hexagon socket ("B" in Figure 5.2). Knurled nut and nut must not be tightened until alignment has been completed.

**Attention!**

The device must not be opened. Failure to comply will render the guarantee void. Warranted features cannot be guaranteed after the device has been opened.

5.2.1 Optional mounting bracket

A mounting bracket for mounting the AMS 335/i on a flat, horizontal surface is available as an optional accessory.

Type designation: MW OMS/AMS 01

Part no.: 50107255

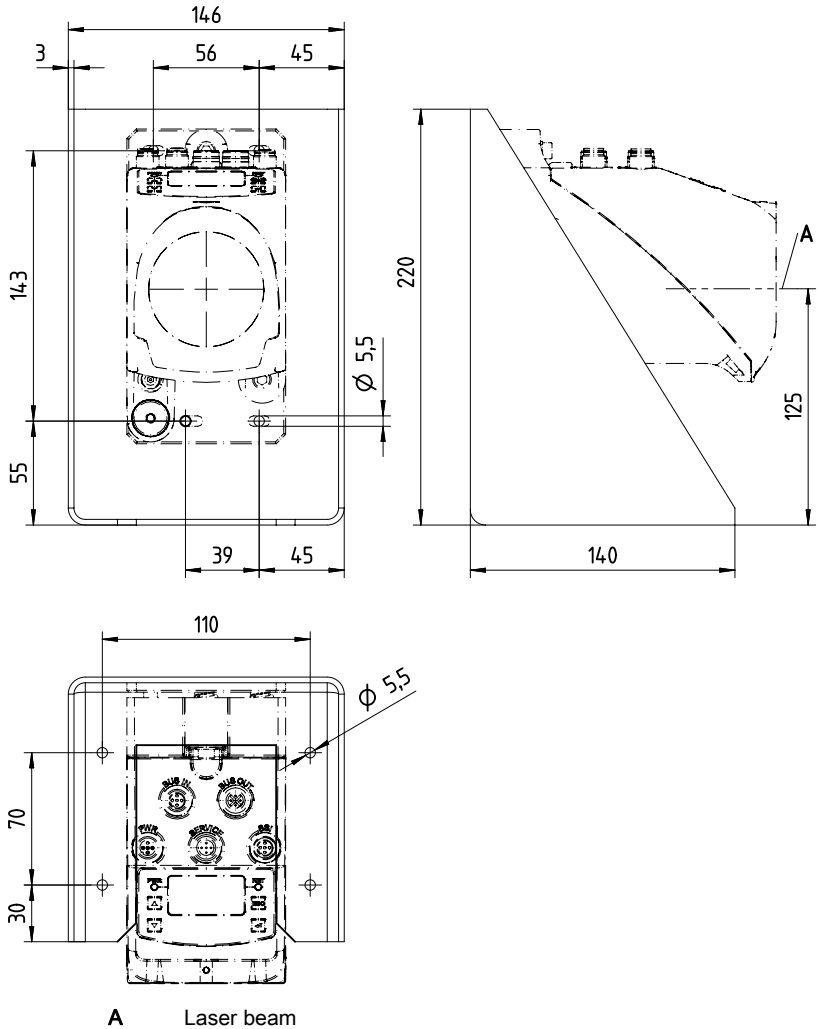

Figure 5.3: Optional mounting bracket

5.2.2 Parallel mounting of the AMS 335/

Definition of the term "parallel spacing"

As shown in Figure 5.4, dimension X describes the "parallel spacing" of the inner edges of the two laser light spots on the reflector.

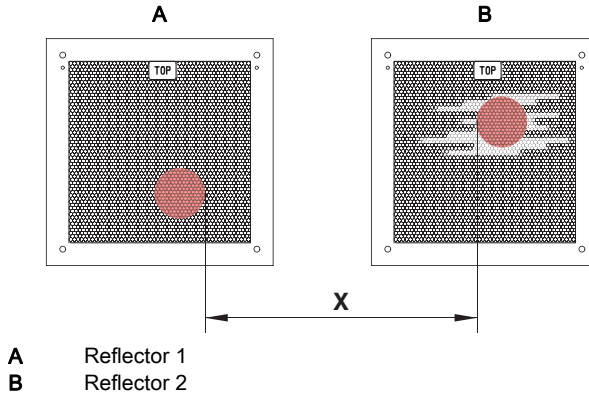

Figure 5.4: Minimum parallel spacing X between adjacent AMS 335/

The diameter of the light spot increases with distance.

	AMS 335/40 (H)	AMS 335/120 (H)	AMS 335/200 (H)	AMS 335/300 (H)
Max. measurement distance	40m	120m	200m	300m
Light spot diameter	≤ 40mm	≤ 100mm	≤ 150mm	≤ 225mm

Thus, the center-to-center spacing of the two AMS 335/ devices with respect to one another can be calculated as a function of the maximum measurement distance.

To define the minimum parallel spacing between two AMS 335/, it is necessary to distinguish between three different arrangements of AMS 335/ and reflectors.

The AMS 335/ are mounted stationary and in parallel on one plane.

Both reflectors move independently of one another at different distances to the AMS 335/.

Minimum parallel spacing X of the two laser light spots:

$$X = 100\text{mm} + (\text{max. measurement distance in mm} \times 0.01)$$

The AMS 335/ are mounted stationary and in parallel on one plane.

Both reflectors move in parallel at the same distance to the AMS 335/.

Measurement distance up to 120m: minimum parallel spacing X ≥ 600mm

Measurement distance up to 200m: minimum parallel spacing X ≥ 750mm

Measurement distance up to 300m: minimum parallel spacing X ≥ 750mm

The reflectors are mounted stationary and in parallel on one plane.

Both AMS 335*i* move independently of one another at different or the same distances to the reflectors.

Measurement distance up to 120m: minimum parallel spacing $X \geq 600\text{mm}$

Measurement distance up to 200m: minimum parallel spacing $X \geq 750\text{mm}$

Measurement distance up to 300m: minimum parallel spacing $X \geq 750\text{mm}$



Note!

*Please note that when the AMS 335*i* are mounted in a mobile manner, travel tolerances could cause the two laser light spots to move towards each other.*

*Take the travel tolerances of the vehicle into account when defining the parallel spacing of adjacent AMS 335*i*.*

5.2.3 Parallel mounting of AMS 335*i* and DDLS optical data transmission

The optical data transceivers of the DDLS series and the AMS 335*i* do not interfere with one another. Depending on the size of the used reflector, the DDLS can be mounted with a minimum parallel spacing of 100mm to the AMS 335*i*. The parallel spacing is independent of the distance.

5.3 Mounting the AMS 335/i with laser beam deflector unit

General information

The two available deflector units are used for the 90° deflection of the laser beam, see "Accessories – Deflector unit" on page 96.



Attention!

*The deflector units are designed for a maximum range of 40m.
Longer distances on request.*

5.3.1 Mounting the laser beam deflector unit with integrated mounting bracket

The AMS 335/i is screwed onto the mechanism of the US AMS 01 deflector unit. The mirror can be mounted for three deflection directions:

1. Upward beam deflection
2. Beam deflection to the left
3. Beam deflection to the right

The deflector unit is mounted on plane-parallel, flat walls or system parts. For error-free position measurement, there must be an unobstructed line-of-sight between the AMS 335/i... and the deflection mirror as well as between the mirror and the reflector.

Use the M5 screws to mount the deflector unit. Secure the screws with a lock washer to protect against loosening caused by vibrations.



Figure 5.5: Mounting variants of the US AMS 01 laser beam deflector unit

5.3.2 Dimensioned drawing of US AMS 01 deflector unit

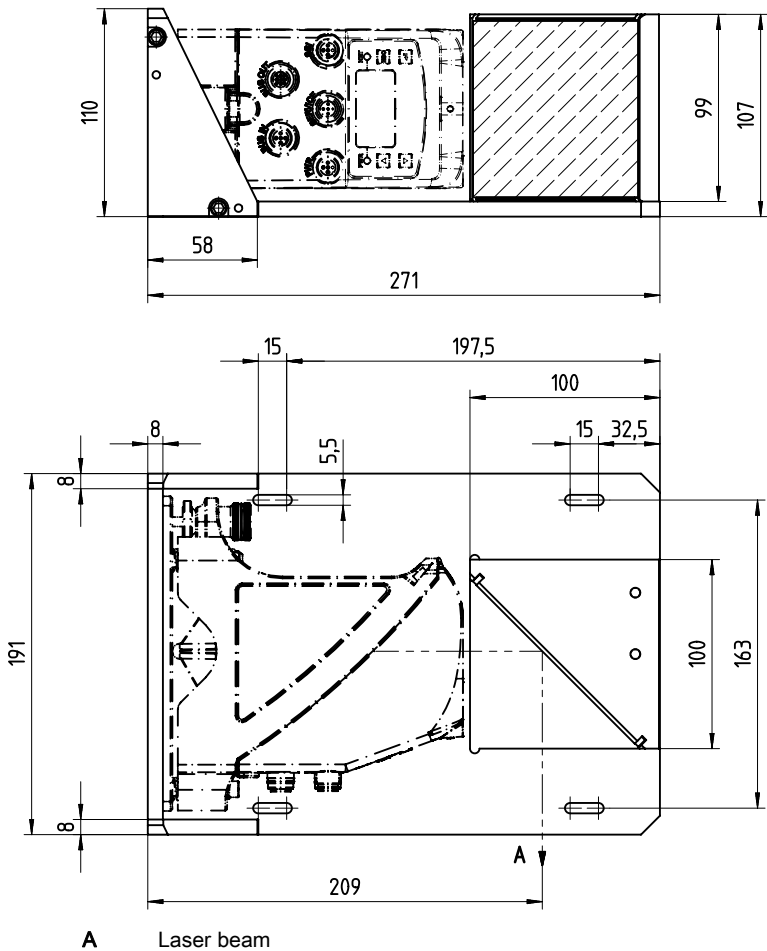

Figure 5.6: Dimensioned drawing of US AMS 01 deflector unit

5.3.3 Mounting the US 1 OMS deflector unit without mounting bracket

The US 1 OMS deflector unit and the AMS 335*i* are mounted separately.



Note!

When mounting, make certain that the laser light spot of the AMS 335*i* is aligned with the center of the deflection mirror.

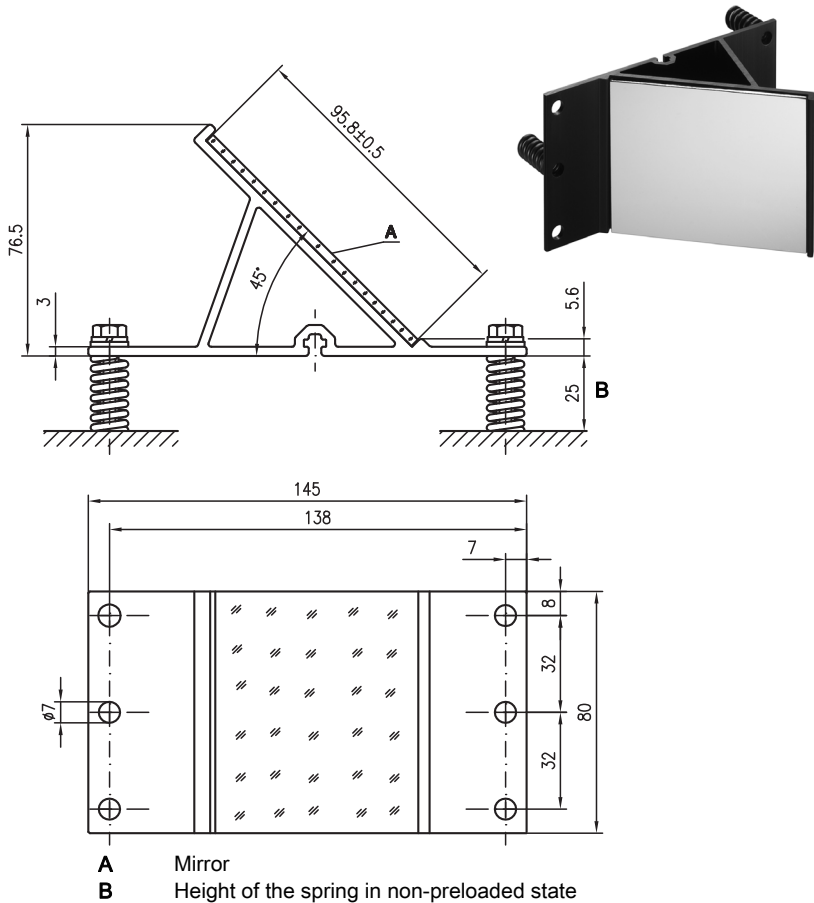

Figure 5.7: Photo and dimensioned drawing of the US 1 OMS deflector unit

The laser light spot is aligned with the reflector as described in Chapter 5.2.

6 Reflectors

6.1 General information

The AMS 335*i* measures distances against a reflective tape specified by Leuze. All technical data given for the AMS 335*i*, such as the operating range or accuracy, can only be achieved with the reflective tape specified by Leuze.

The reflective tapes are available as self-adhesive tapes or affixed to a carrier plate and with an integrated heater especially for use at low temperatures. Reflective tapes with heating have the designation "**Reflective tape ...x...-H**", where "**H**" is an abbreviation for the heating variant.

The reflective tapes/reflectors must be ordered separately. The choice of size is left to the user. In Chapter 6.3, recommendations on reflector size are given depending on the distance that is to be measured. In each case, the user must check whether the recommendation is suitable for the respective application.

6.2 Description of the reflective tape

The reflective tape consists of a white, microprism-based reflective material. The microprisms are protected by a hard, highly transparent protective layer.

Under certain circumstances, the protective layer can cause surface reflections. The surface reflections can be directed past the AMS 335*i* by positioning the reflective tape at a slight incline. The inclination of the reflective tape/reflectors is described in Chapter 6.4.2. The required pitch can be found in Table 6.1 "Reflector pitch resulting from spacer sleeves" on page 36.

The reflective tapes have a protective film that is easy to peel off. It must be removed from the reflector before the complete system is put into operation.

6.2.1 Technical data of self-adhesive tape

	Article				
Type designation	Reflective tape 200x200-S	Reflective tape 500x500-S	Reflective tape 914x914-S	REF 4-A- 150x150	REF 4-A- 300x300
Part no.	50104361	50104362	50108988	50141015	50141014
Film size	200 x 200 mm	500 x 500 mm	914x914 mm	150 x 150 mm	300 x 300 mm
Recommended application temperature for adhesive tape	+5°C ... +25°C				
Temperature resistance, affixed	-40°C ... +80°C				
Bonding surface	The bonding surface must be clean, dry and free of grease.				
Cutting tape	Cut with a sharp tool, always on the side with the prism structure.				
Cleaning	Do not use any abrasive agents. A conventional household detergent can be used as a cleaning agent. Rinse with clear water and dry the surface.				
Film storage	Store in a cool and dry place.				

6.2.2 Technical data of reflective tape on carrier plate

The reflective tape is affixed to a carrier plate. Included with the carrier plate are spacers for positioning at an incline in order to avoid surface reflections (see chapter 6.4.2 "Mounting the reflector").

	Article		
Type designation	Reflective tape 200x200-M	Reflective tape 500x500-M	Reflective tape 914x914-M
Part no.	50104364	50104365	50104366
Film size	200 x 200 mm	500 x 500 mm	914x914 mm
Outer dimensions of carrier plate	250 x 250 mm	550 x 550 mm	964 x 964 mm
Weight	0.4 kg	1.6 kg	6 kg
Cleaning	Do not use any abrasive agents. A conventional household detergent can be used as a cleaning agent. Rinse with clear water and dry the surface.		
Reflector storage	Store in a cool and dry place.		

6.2.3 Dimensioned drawing of reflective tape on carrier plate

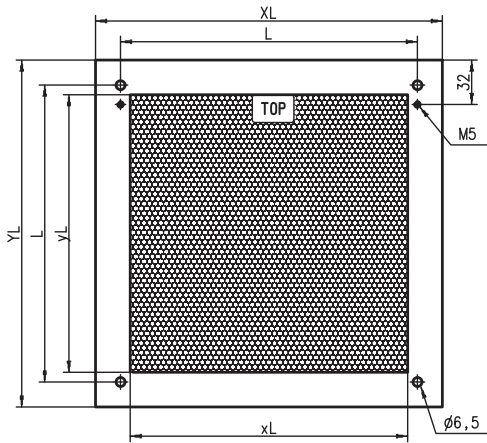

 Always align the **TOP** marking with the AMS connections! (Chapter 6.4.2)

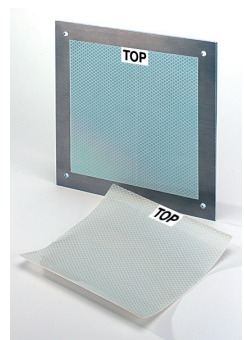

Figure 6.1: Dimensioned drawing of reflectors

Article	Reflective tape (mm)		Reflector plate (mm)		
	xL	yL	XL	YL	L
Reflective tape 200x200-M	200	200	250	250	214
Reflective tape 500x500-M	500	500	550	550	514
Reflective tape 914x914-M	914	914	964	964	928

6.2.4 Technical data of heated reflectors

The reflective tape is affixed to a heated, thermally insulated carrier. The insulation results in a very high energetic efficiency.

Only the reflective tape is kept at the specified temperature by the integrated heater. The insulation on the back prevents the generated heat from being dissipated via the steel construction. Energy costs are greatly reduced in the case of continuous heating.

Type designation	Article		
	Reflective tape 200x200-H	Reflective tape 500x500-H	Reflective tape 914x914-H
Part no.	50115020	50115021	50115022
Voltage supply	230VAC		
Power	100W	600W	1800W
Current consumption	~ 0.5A	~ 3A	~ 8A
Length of supply line	2 m		
Size of reflective tape	200 x 200mm	500 x 500mm	914 x 914mm
Outer dimensions of base material	250 x 250mm	550 x 550mm	964 x 964mm
Weight	0.5kg	2.5kg	12kg
Temperature control	Controlled heating with the following switch-on and switch-off temperatures, measured at the reflector surface.		
Switch-on temperature	~ 5°C		
Switch-off temperature	~ 20°C		
Operating temperature	-30°C ... +70°C		
Storage temperature	-40°C ... +80°C		
Air humidity	Max. 90%, non-condensing		
Cleaning	Do not use any abrasive agents. A conventional household detergent can be used as a cleaning agent. Rinse with clear water and dry the surface.		
Reflector storage	Store in a cool and dry place.		

6.2.5 Dimensioned drawing of heated reflectors

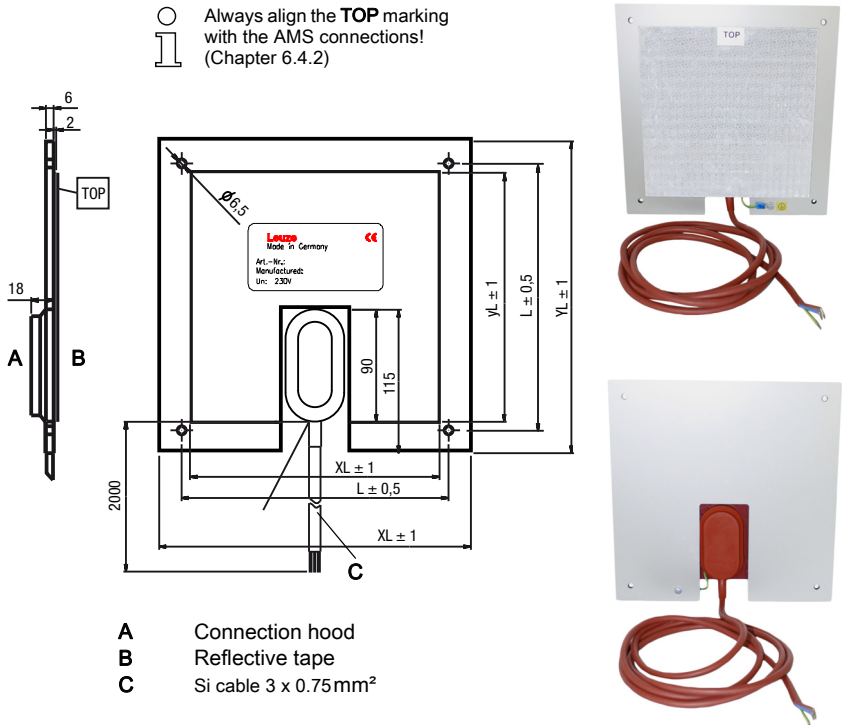

Figure 6.2: Dimensioned drawing of heated reflectors

Article	Reflective tape (mm)		Insulated carrier plate (mm)		
	xL	yL	XL	YL	L
Reflective tape 200x200-H	200	200	250	250	214
Reflective tape 500x500-H	500	500	550	550	514
Reflective tape 914x914-H	914	914	964	964	928

6.3 Selecting reflector size

Depending on the system design, the reflector can be mounted so that it moves with the vehicle or it can be mounted at a fixed location.



Attention!

The reflector sizes shown below are a recommendation from Leuze for on-vehicle mounting of the AMS 335*i*. For stationary mounting of the AMS 335*i*, a smaller reflector is generally sufficient for all measurement distances. For this reason, two smaller reflector sizes are available in the self-adhesive variant "-S".

During system planning and design, always check whether mechanical travel tolerances require the use of a reflector larger than that which is recommended. This applies, in particular, when the laser measurement system is mounted on a vehicle. During travel, the laser beam must reach the reflector unobstructed. For on-vehicle mounting of the AMS 335*i*, the reflector size must accommodate any travel tolerances that may arise and the associated "wandering" of the light spot on the reflector.

Overview of reflector types

Recommended reflector size			
Selected AMS 335 <i>i</i> (operating range in m)	Recommended reflector size (H x W)	Type designation ...-S = self-adhesive ...-M = Carrier plate ...-H = heating	Part no.
AMS 335 <i>i</i> 40 (max. 40m)	200 x 200mm	REF 4-A-150x150 ¹⁾ Reflective tape 200x200-S Reflective tape 200x200-M Reflective tape 200x200-H REF 4-A-300x300 ¹⁾	50141015 50104361 50104364 50115020 50141014
AMS 335 <i>i</i> 120 (max. 120m)	500x500mm	Reflective tape 500x500-S Reflective tape 500x500-M Reflective tape 500x500-H	50104362 50104365 50115021
AMS 335 <i>i</i> 200 (max. 200m)	749x914mm 914x914mm	Reflective tape 749x914-S Reflective tape 914x914-M Reflective tape 914x914-S Reflective tape 914x914-H	50104363 50104366 50108988 50115022
AMS 335 <i>i</i> 300 (max. 300m)	749x914mm 914x914mm	Reflective tape 749x914-S Reflective tape 914x914-M Reflective tape 914x914-S Reflective tape 914x914-H	50104363 50104366 50108988 50115022

1) For roadside mounting

6.4 Mounting the reflector

6.4.1 General information

Self-adhesive reflective tapes

The reflective tapes of the "Reflective tape ...x...-S" series (self-adhesive) must be affixed to a flat, clean and grease-free surface. We recommend using a separate carrier plate, which is to be provided on-site.

As described in Table 6.1, the reflective tape must be at an angle.

Reflective tapes on carrier plate

The reflective tapes of the "Reflective tape ...x...-M" series have corresponding mounting holes. Spacer sleeves are provided to enable mounting at the necessary pitch angle. For further information, see Table 6.1.

Heated reflectors

The reflective tapes of the "Reflective tape ...x...-H" series have corresponding mounting holes. Due to the voltage supply affixed on the rear, the reflector cannot be mounted flat. Four spacer sleeves in two different lengths are supplied. Use the spacer sleeves to ensure separation from the wall as well as to provide the necessary pitch for avoiding surface reflection. For further information, see Table 6.1.

The reflector has a 2m-long connection cable for supplying with 230VAC. Connect the cable to the nearest power distribution point. Observe the current consumptions listed in the technical data.



Attention!

Connection work must be carried out by a certified electrician.

6.4.2 Mounting the reflector

The combination of laser measurement system and reflective tape/reflector is mounted so that the laser light spot hits the film as centered as possible and without obstruction.

For this purpose, use the alignment elements provided on the AMS 335*i*... (see chapter 5.2 "Mounting the AMS 335"). If necessary, remove the protective film from the reflector.



Attention!

The "TOP" label on the reflectors should be aligned the same as the connections of the AMS 335*i*.

Example:

*If the AMS 335*i* is mounted so that the M12 connections are on the top, the "TOP" label of the reflector is also on the top. If the AMS 335*i* is mounted so that the M12 connections are on the side, the "TOP" label of the reflector is also on the side.*



Note!

The reflector must be positioned at an angle. Use the spacer sleeves for this purpose. Angle the reflector so that the **surface reflections of the foil seal are deflected to the left, right or upwards**. Chapter 6.4.3 gives the correct pitch with respect to the reflector size and, thus, the length of the spacers.

Reflective tapes ...-S and ...-M

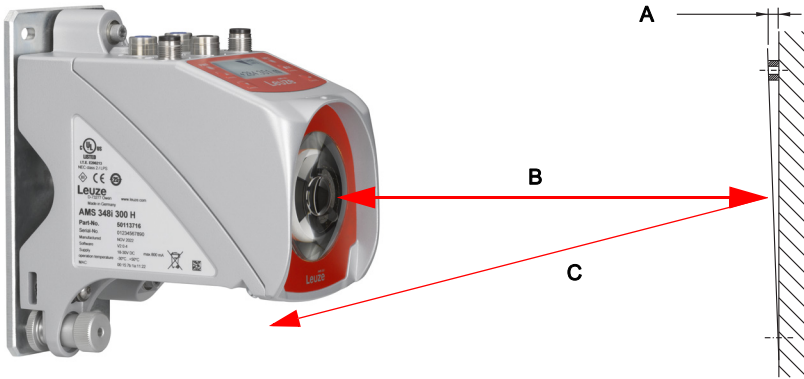

- A** Pitch approx. 1°
- B** Direct reflection due to the triple structure
- C** Deflected surface reflection due to the pitch of the reflective tape

Figure 6.3: Mounting the reflector

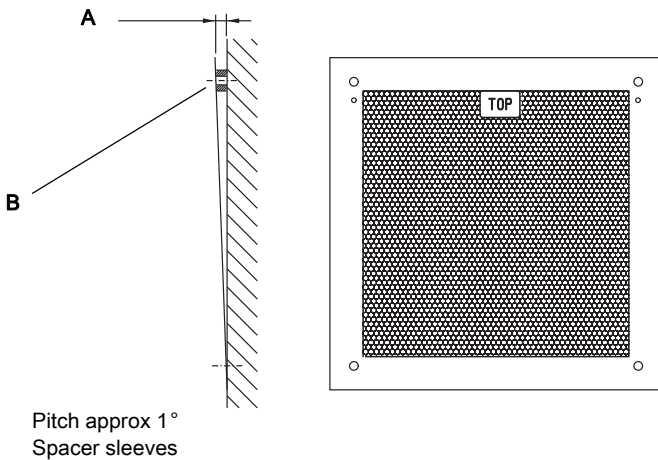

- A** Pitch approx 1°
- B** Spacer sleeves

Figure 6.4: Pitch of the reflector

Reflective tapes ...-H

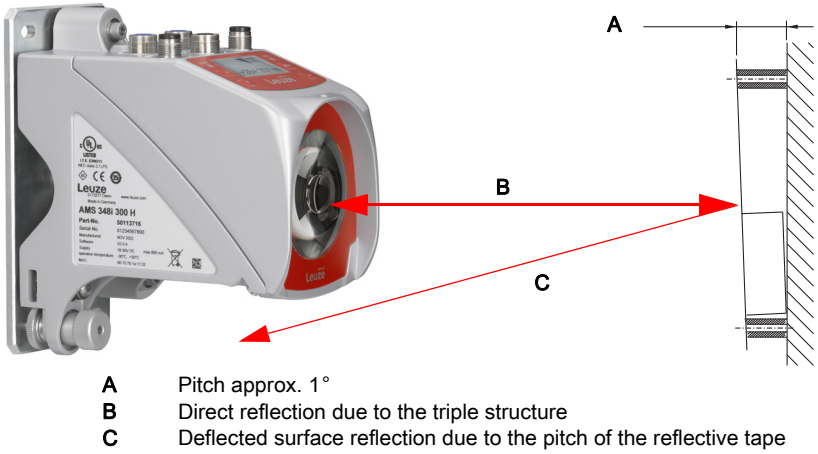

Figure 6.5: Mounting of heated reflectors

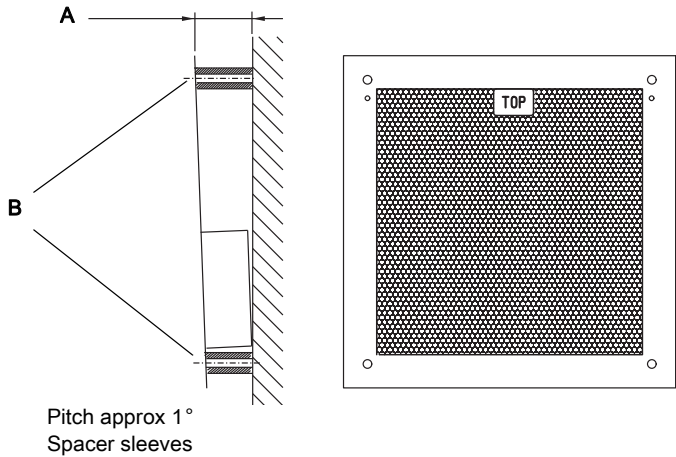

Figure 6.6: Pitch of the heated reflector

6.4.3 Table of reflector pitches

Reflector type	Pitch resulting from spacer sleeves ¹⁾	
Reflective tape 200x200-S Reflective tape 200x200-M	2 x 5mm	
Reflective tape 200x200-H	2 x 15mm	2 x 20mm
Reflective tape 500x500-S Reflective tape 500x500-M	2 x 10mm	
Reflective tape 500x500-H	2 x 15mm	2 x 25mm
Reflective tape 749x914-S	2 x 20mm	
Reflective tape 914x914-S Reflective tape 914x914-M	2 x 20mm	
Reflective tape 914x914-H	2 x 15mm	2 x 35mm

1) Spacer sleeves are included with reflective tape ...-M and ...-H

Table 6.1: Reflector pitch resulting from spacer sleeves



Note!

Reliable operation of the AMS 335*i* and, thus, max. operating range and accuracy can only be achieved with the reflective tape specified by Leuze. Correct operation cannot be guaranteed if other reflectors are used!

7 Electrical connection

The AMS 335*i* laser measurement systems are connected using variously coded M12 connectors. This ensures unique connection assignments.



Note!

The corresponding mating connectors and ready-made cables are available as accessories for all connections. For further information, see chapter 11 "Type overview and accessories".

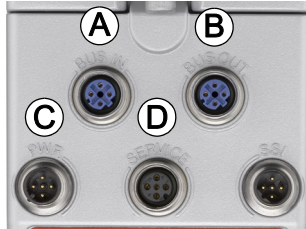

- A BUS IN, M12 connector (A-coded)
- B BUS OUT, M12 socket (A-coded)
- C PWR / IOs, M12 connector (A-coded)
- D Leuze SERVICE, M12 socket (A-coded)

Figure 7.1: Connections of the AMS 335*i*

7.1 Safety notices for the electrical connection



Attention!

Before connecting the device, be sure that the supply voltage agrees with the value printed on the name plate.

The device may only be connected by a qualified electrician.

Ensure that the functional earth (FE) is connected correctly. Unimpaired operation is only guaranteed when the functional earth is connected properly.

If faults cannot be cleared, the device should be switched off and protected against accidental use.



Attention!

For UL applications, use is only permitted in Class 2 circuits in accordance with the NEC (National Electric Code).



The laser measurement systems are designed in accordance with protection class III for supply by PELV (protective extra-low voltage with reliable disconnection).



Note!

Degree of protection IP65 is achieved only if the connectors and caps are screwed into place!

Described in detail in the following are the individual connections and pin assignments.

7.2 PWR – voltage supply / switching input/output

PWR (5-pin connector, A-coded)			
 <p>M12 connector (A-coded)</p>	Pin	Name	Comment
	1	VIN	Positive supply voltage +18 ... +30VDC
	2	I/O 1	Switching input/output 1
	3	GNDIN	Negative supply voltage 0VDC
	4	I/O 2	Switching input/output 2
	5	FE	Functional earth
	Thread	FE	Functional earth (housing)

Table 7.1: Pin assignments - PWR

Further information on configuring the input/output can be found in Chapter 8 and Chapter 9.

7.3 CANopen BUS IN

BUS IN (5-pin connector, A-coded)			
 <p>M12 connector (A-coded)</p>	Pin	Name	Comment
	1	Drain	Shield
	2	NC	Not assigned
	3	NC	Not assigned
	4	CAN_H	Data signal CAN_H
	5	CAN_L	Data signal CAN_L
	Thread	FE	Functional earth (housing)

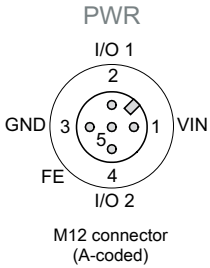
Table 7.2: Pin assignment for CANopen BUS IN

7.4 CANopen BUS OUT

BUS OUT (5-pin socket, A-coded)			
 <p>M12 socket (A-coded)</p>	Pin	Name	Comment
	1	Drain	Shield
	2	NC	Not assigned
	3	NC	Not assigned
	4	CAN_H	Data signal CAN_H
	5	CAN_L	Data signal CAN_L
	Thread	FE	Functional earth (housing)

Table 7.3: Pin assignment for CANopen BUS OUT

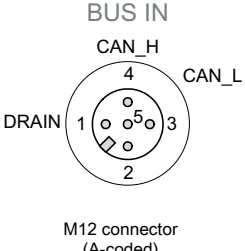
7.5 Service

Service (5-pin socket, A-coded)			
 <p>M12 socket (A-coded)</p>	Pin	Name	Comment
	1	NC	Not assigned
	2	RS232-TX	RS 232 transmission line/ service data
	3	GND	Voltage supply 0VDC
	4	RS232-RX	RS 232 receiving line/ service data
	5	NC	Not used
	Thread	FE	Functional earth (housing)

Table 7.4: Pin assignment - Service

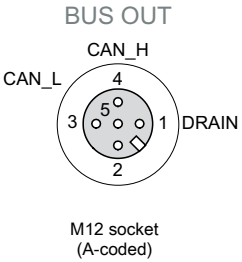

Note!

The service interface is designed only for use by Leuze!

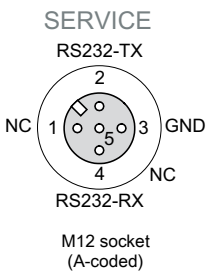
8 Display and control panel AMS 335*i*

8.1 Structure of the control panel

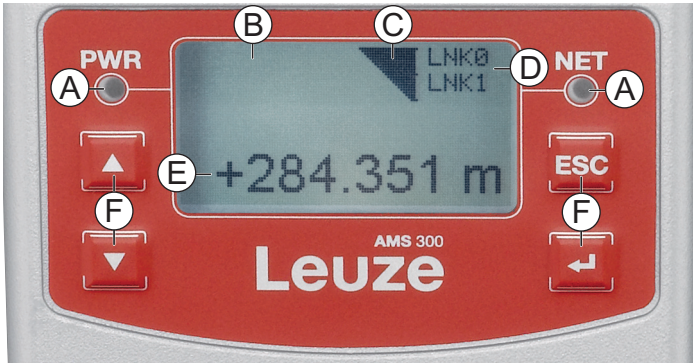

- A LED
- B Status indicator
- C Bargraph
- D Bus/interface info
- E Distance measurement value
- F Control buttons

Figure 8.1: Structure of the control panel using the AMS 304*i*/PROFIBUS device variant as an example



Note!

*The figure is for illustration purposes only and does not correspond to the AMS 335*i* with respect to specified bus/interface info.*

8.2 Status indicators and operation

8.2.1 Indicators in the display

Status and warning messages in the display

- IO1 **Input 1 or output 1 active:**
Function depending on configuration.
- IO2 **Input 2 or output 2 active:**
Function depending on configuration.
- LSR **Warning - laser preailure message:**
Laser diode old, device still functional, exchange or have repaired.
- TMP **Warning - temperature monitoring:**
Internal device temperature above/below permissible range.

- PLB **Plausibility error:**
Implausible measurement value. Possible causes: light beam interruption, outside of measurement range, permissible internal device temperature considerably exceeded or traverse rate >10m/s.
Depending on the configuration, either zero or the last valid measurement value is output at the interfaces.
- ATT **Warning - received signal:**
Laser exit window or reflector soiled or fogged by rain, water vapor or fog. Clean or dry surfaces.
- ERR **Internal hardware error:**
The device must be sent in for inspection.

Bar graph



Indicates the **strength of the received laser light**.
The center bar represents the **ATT** warning threshold. The distance value remains valid and is output at the interfaces.
If no bar graph is available, the **PLB** status information appears at the same time.
The measurement value is assessed as implausible. Depending on the configuration, either zero or the last valid measurement value is output at the interfaces.

Interface info

An activated CANopen interface is indicated by the presence of Node ID (bus address) and the "CAN" ID in the display. If the CANopen interface is deactivated, the Node ID and CAN ID are hidden from view.

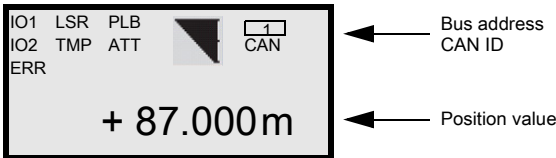

Position value

The measured position value is displayed in the configured unit of measurement.

- +87.000m With the **metric** setting, the measurement value is always displayed in meters to **three decimal places**.
- +87.0in With the **inch** setting, the measurement value is always displayed in inches to **one decimal place**.

8.2.2 LED status indicators

PWR LED

PWR

**Off****Device OFF**

- No supply voltage

PWR

**Flashing green****Power LED flashes green**

- No measurement value output
- Voltage connected
- Self test running
- Initialization running
- Boot process running

PWR

**Green continuous light****Power LED green**

- AMS 335*i* OK
- Measurement value output
- Self test successfully finished
- Device monitoring active

PWR

**Red flashing****Power LED flashes red**

- Device OK but warning message (ATT, TMP, LSR) set in display
- Light beam interruption
- Plausibility error (PLB)

PWR

**Red continuous light****Power LED red**

- No measurement value output; for details, see display

PWR

**Orange continuous light****Power LED orange**





- Parameter enable active
- No data on the host interface

NET LED





NET

**Off****LED off**



- No voltage supply
- Bus ok

NET 	Flashing green	LED flashes green - "PRE-OPERATIONAL" state - "STOPPED" state
NET 	Green continuous light	LED is green - "OPERATIONAL" state
NET 	Flashing red	LED flashes red - Invalid configuration
NET 	Red continuous light	LED red - No bus connection
	Flashing green/red	LED flashes green/red - Bus error - Time out - RX/TX buffer overflow - Termination error

8.2.3 Control buttons

	Up	Navigate upward/sideways.
	Down	Navigate downward/sideways.
	ESC	Exit menu item.
	ENTER	Confirm/enter value, change menu levels.

Navigating within the menus

The menus within a level are selected with the up/down buttons  .

The selected menu item is activated with the enter button .

Press the ESC button  to move up one menu level.

When one of the buttons is actuated, the display illumination is activated for 10 min.

Setting values

If input of a value is possible, the display looks like this:

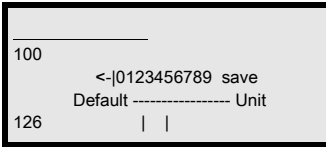

- + Delete character
- + Enter digit
- save** + Save

Use the and buttons to set the desired value. An accidental, incorrect entry can be corrected by selecting <-| and then pressing .

Then use the buttons to select save and save the set value by pressing .

Selecting options

If options can be selected, the display looks like this:

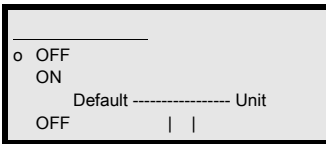

Select the desired option with the buttons. Activate the option by pressing .

8.3 Menu description

8.3.1 The main menus

After voltage has been applied to the laser, device information is displayed for several seconds. The display then shows the measurement window with all status information.

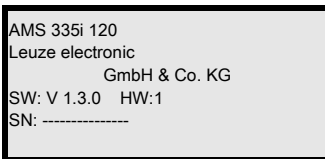

Device information - main menu

This menu item contains detailed information on

- Device type
- Manufacturer
- Software and hardware version
- Serial number

No entries can be made via the display.

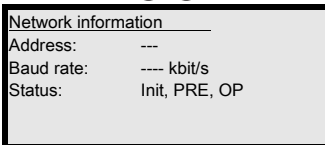

Network information - main menu

- Explanations of address, baud rate, status.

No entries can be made via the display.



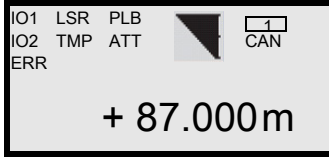

Status and measurement data - main menu

- Display of status, warning and error messages.
- Status overview of the switching inputs/outputs
- Bar graph for the received signal level.
- Link
- Measurement value. No entries can be made via the display.

See "Indicators in the display" on page 40.

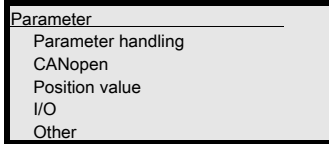

Parameter - main menu

- Configuration of the AMS.
- See "Parameter menu" on page 45.

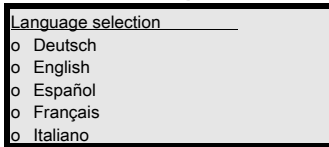

Language selection - main menu

- Selection of the display language.
- See "Language selection menu" on page 50.

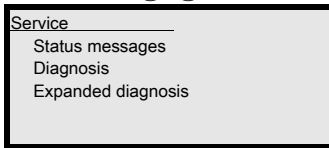

Service - main menu

- Display of status messages.
 - Display of diagnostic data.
- No entries can be made via the display.
See "Service menu" on page 50.



Note!

The rear cover of this manual includes a fold-out page with the complete menu structure. It describes the menu items in brief.

8.3.2 Parameter menu

Parameter handling submenu

The following functions can be called up in the Parameter handling submenu:

- Lock and enable parameter entry
- Set up a password
- Reset the AMS 335*i* to the default settings

Table 8.1: Parameter handling submenu

Level 3	Level 4	Level 5	Selection/configuration option Description	Standard
Parameter enable			ON/OFF The standard setting (OFF) prevents unintended parameter changes. With parameter enable activated (ON), the display is inverted. In this state, it is possible to change parameters manually.	OFF

Table 8.1: Parameter handling submenu

Level 3	Level 4	Level 5	Selection/configuration option Description	Standard
Password	Activate password		ON/OFF To enter a password, parameter enable must be activated. If a password is assigned, changes to the AMS 335i can only be made after the password is entered. The master password 2301 overrides the individually set password.	OFF
	Password entry		For setting a four-digit numerical password.	
Parameters to default			By pressing the enter button (↵) after selecting Parameters to default, all parameters are reset to their standard settings without any further security prompts. In this case, English is selected as the display language.	

Additional important information on parameter handling can be found at the end of the chapter.

CANopen submenu

Tabelle 8.2: CANopen submenu

Level 3	Level 4	Level 5	Selection/configuration option Description	Standard
Activation			ON/OFF	ON
Node ID			Value range: 1 ... 127	1
Baud rate			20kbit/s / 50kbit/s / 125kbit/s / 250kbit/s / 500kbit/s / 800kbit/s / 1000kbit/s Selection of the serial communication baud rate. The baud rate specifies the velocity of the data transmission. It must be identical on transmitter and receiver side in order to enable communication.	125kbit/s
Position resolution			0.01 mm / 0.1 mm / 1 mm / 10 mm / free resolution The measurement value can be displayed in these resolutions. The value of the free resolution is determined in the "Position value" submenu in the "Free resolution value" parameter.	1mm
Velocity resolution			1 mm / 10 mm / 100 mm / 1000 mm / free resolution The current velocity can be displayed in these resolutions. The value of the free resolution is determined in the "Velocity" submenu in the "Free resolution value" parameter.	1 mm/s

Position value submenu



Note!

The parameters named under position value are to be set via the EDS file of the AMS 335i. If parameters from the position value submenu are changed via the display, these may be overwritten via a startup sequence stored in the control.

Table 8.3: Position value submenu

Level 3	Level 4	Level 5	Selection/configuration option Description	Standard
Unit			Metric/Inch Specifies the units of the measured distances	Metric
Counting direction			Positive/Negative Positive: The measurement value begins at 0 and increases with increasing distance. Negative: The measurement value begins at 0 and decreases with increasing distance. Negative distance values may need to be compensated with an offset or preset.	Positive
Offset			Output value = measurement value + offset The resolution of the offset value is independent of the selected "Position resolution" and is entered in mm or inch/100. The offset value is effective immediately after entry. If the preset value is activated, this has priority over the offset. Preset and offset are not offset against each other.	0 mm
Preset			The preset value is accepted by means of teach pulse. The teach pulse can be applied to a hardware input of the M12 PWR connector. The hardware input must be appropriately configured. See also configuration of the I/Os.	0 mm
Free resolution value			The measurement value can be resolved in increments of 1/1000 within the 5 ... 50000 value range. If e.g. a resolution of 0.875mm per digit is required, the parameter is set to 875. In the activated interface, the measurement value display must also be set to "free resolution" ("Position resolution" parameter).	1000
Error delay			ON/OFF Specifies whether, in the event of an error, the position value immediately outputs the value of the "Position value in the case of failure" parameter or the last valid position value for the configured error delay time.	ON/100 ms
Position value in the case of failure			Last valid value / zero Specifies which position value is output after the error delay time elapses.	Zero

I/O submenu

Table 8.4: I/O submenu

Level 3	Level 4	Level 5	Selection/configuration option Description	Standard
I/O 1	Port configuration		Input/Output Defines whether I/O 1 functions as an output or input.	Output
	Switching input	Function	No function/teach preset/laser ON/OFF	No function
		Activation	Low active/High active	Low active

Table 8.4: I/O submenu

Level 3	Level 4	Level 5	Selection/configuration option Description	Standard
	Switching output	Function	Pos. limit value 1 / Pos. limit value 2 / Velocity / Intensity (ATT) / Temp. (TMP) / Laser (LSR) / Plausibility (PLB) / Hardware (ERR) The individual functions are "ORed" on the selected switching output.	Plausibility (PLB), hardware (ERR)
		Activation	Low active/High active	Low active
I/O 2	Port configuration		Input/Output Defines whether I/O 2 functions as an output or input.	Output
	Switching input	Function	No function/teach preset/laser ON/OFF	No function
		Activation	Low active/High active	Low active
	Switching output	Function	Pos. limit value 1 / Pos. limit value 2 / Velocity / Intensity (ATT) / Temp. (TMP) / Laser (LSR) / Plausibility (PLB) / Hardware (ERR) The individual functions are "ORed" on the selected switching output.	Intensity (ATT), Temp. (TMP), Laser (LSR)
		Activation	Low active/High active	Low active
Limit values	Upper pos. limit 1	Activation	ON/OFF	OFF
		Limit value input	Value input in mm or inch/100	0
	Lower pos. limit 1	Activation	ON/OFF	OFF
		Limit value input	Value input in mm or inch/100	0
	Upper pos. limit 2	Activation	ON/OFF	OFF
		Limit value input	Value input in mm or inch/100	0
	Lower pos. limit 2	Activation	ON/OFF	OFF
		Limit value input	Value input in mm or inch/100	0

Other submenu

Table 8.5: Other submenu

Level 3	Level 4	Level 5	Selection/configuration option Description	Standard
Heating control			Standard (10°C ... 15°C)/Extended (30°C ... 35°) Defines a switch-on/switch-off range for the heating control. The extended switch-on/switch-off range for heating may provide a remedy in the event of condensation problems. Due to the limited heating capacity, it cannot be guaranteed that no condensation will form on the optics in the extended switch-on/switch-off range. This parameter is available as standard, but functions only for devices with integrated heating (AMS 335 <i>i</i> ... H).	Standard
Display illumination			10 minutes/ON Display illumination is switched off after 10 minutes or, if the parameter is set to "ON", illumination is always on.	10 min
Display contrast			Weak/Medium/Strong The display contrast may change at extreme temperature values. The contrast can subsequently be adapted using the three levels.	Medium
Service RS232	Baud rate		57.6kbit/s / 115.2kbit/s The service interface is only available to Leuze personnel.	115.2kbit/s
	Format		8,e,1 / 8,n,1 The service interface is only available to Leuze personnel.	8,n,1

8.3.3 Language selection menu

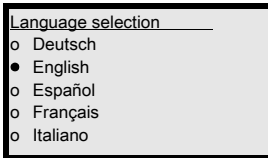

5 display languages are available:

- German
- English
- Spanish
- French
- Italian

The AMS 335*i* is delivered from the factory with the display preset to English.



Note!

*When operating the AMS 335*i* on the CANopen, the language configured in the EDS file is used in the display.*

To change the language, no password needs to be entered nor must parameter enable be active. The display language is a passive operational control and is therefore not a function parameter per se.

8.3.4 Service menu

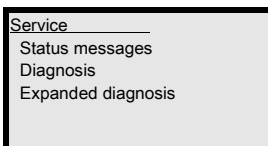

A detailed description of the individual functions can be found in Chapter 10.

8.4 Operation

An operating process is described here using parameter enable as an example.

Parameter enable

During normal operation parameters can be viewed only. If parameters are to be changed, the ON menu item in the Parameter -> Parameter handling -> Parameter enable menu must be activated. To do this, proceed as follows.

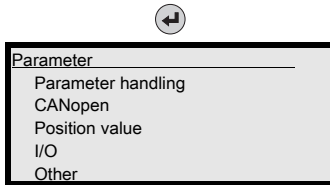

In the main menu, press the enter button to enter the Parameter menu.

Use the ▲▼ buttons to select the Parameter handling menu item.

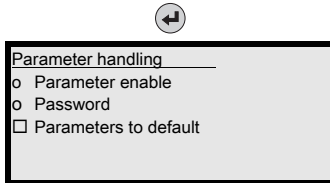

Press the enter button to enter the Parameter handling menu.

In the Parameter handling menu, use the ▲▼ buttons to select the Parameter enable menu item.

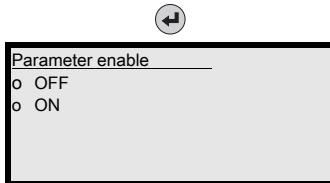

Press the enter button to enter the Parameter enable menu.

In the Parameter enable menu, use the ▲▼ buttons to select the ON menu item.



Press the enter button to activate parameter enable.

The PWR LED lights up orange; the display is inverted. You can now set the individual parameters on the display.

Press the ESC button twice to return to the Parameter menu.



Viewing and editing parameters

As long as parameter enable is active, the entire AMS 335i display is inverted.

As long as parameter enable is active, communication between control and AMS 335i is interrupted. The extended networking via BUS OUT is retained.

**Note!**

If a password was stored, parameter enable is not possible until this password is entered; see "Password for parameter enable" below.

Password for parameter enable

Parameter entry on the AMS 335*i* can be protected with a password. With the AMS 335*i*, the password is defined via the EDS file (class 100, instance 1). Therefore, the password cannot be changed by means of display entry.

To activate parameter enable via the display (e.g. for changing an address), the password defined in the EDS file must be entered. If parameter enable has been activated after successfully entering the password, parameters can be temporarily changed via the display. After parameter enable is deactivated, all changes made on the display are overwritten by the start-up sequence that may be stored in the control (see above). If a new password has been assigned, this, too, is overwritten by the password defined in the EDS file.

**Note!**

*The master password 2301 can enable the AMS 335*i* at any time.*

9 CANopen interface

9.1 General information on CANopen

9.1.1 Topology

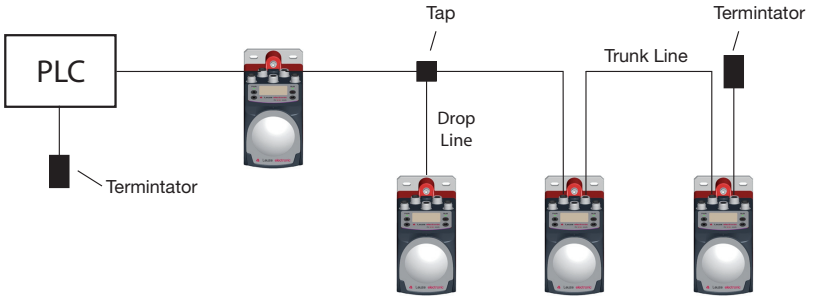

Figure 9.1: Bus topology

The CAN bus is a serial 2-wire bus system to which all participants are connected in parallel (i.e., using short stub cables). To avoid reflections, the bus must be terminated with a terminating resistor of 120ohm at each end of the trunk line. Terminating resistors are also required for very short trunk line cable lengths.

If the AMS 335/i is the last participant in the trunk line, the trunk line can be terminated via the M12 BUS OUT connection. For this purpose, Leuze electronic offers an M12 terminating resistor, see chapter 11 "Type overview and accessories".

9.1.2 Bus line (trunk line)

For CAN, the maximum cable length of the trunk line is predominantly limited by the signal propagation time. The multi-master bus-access process (arbitration) requires that the signals are present virtually simultaneously at all nodes/participants. Therefore, the cable length of the trunk cable must be adapted to the baud rate.

Baud rate	Bus length
1 Mbit/s	< 20m
800kbit/s	< 50m
500kbit/s	< 100m
250kbit/s	< 250m
125kbit/s	< 500m
50kbit/s	< 1000m
20kbit/s	< 2500m

9.1.3 Stub cables (drop lines)

If possible, drop lines should be avoided because they always cause signal reflections. Generally, the reflections caused by stub cables are not critical, however, if the following stub cable lengths are not exceeded.

Baud rate	Length of stub cable	Total length of all stub cables
1 Mbit/s	< 1 m	< 5 m
800 kbit/s	< 1 m	< 25 m
500 kbit/s	< 1 m	< 25 m
250 kbit/s	< 10 m	< 50 m
125 kbit/s	< 20 m	< 100 m
50 kbit/s	< 50 m	< 250 m
20 kbit/s	< 50 m	< 250 m



Attention!

Stub cables (drop lines) must not be fitted with terminating resistors. If the AMS 335*i* is integrated into a stub cable, the M12 bus OUT connection must not be terminated.

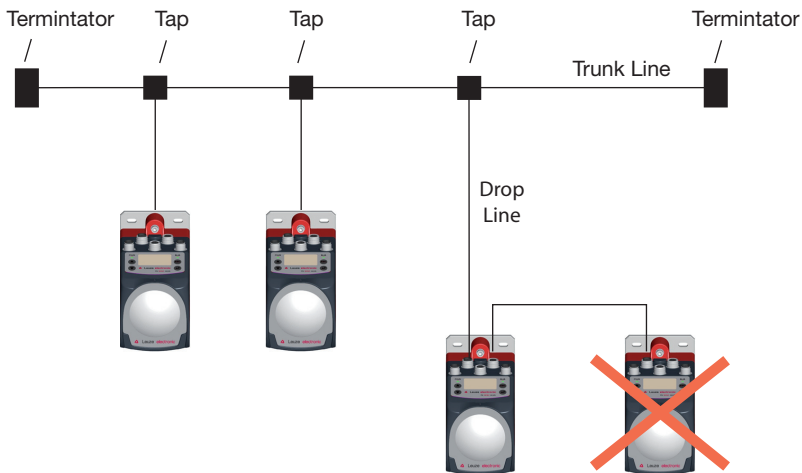

Figure 9.1: Prohibited networking within a stub cable



Attention!

AMS 335*i* should not be networked with each other within a stub cable. The max. permissible length of a stub cable must not be exceeded. Taps and multi-taps permit a wide range of topologies.

9.2 Address assignment

**Note!**

The participant-specific address for CANopen is also called the Node ID. Throughout this handbook, the term "address" is used, which is identical to Node ID.

Each participant connected to CANopen is assigned its own address (Node ID).

Up to 127 participants can be connected to one network. The addresses range from 1 to 127. The address 0 is usually reserved for the CANopen master.

**Note!**

The "Layer Setting Services (LSS)" function is not supported by the AMS 335*i*. For this reason, the address must be set manually via the display/panel of the AMS.

9.2.1 Entering the address via the display

To enter the address via the display, proceed as follows:

- ↵ *Activate Parameter enable.*
- ↵ *Select the CANopen submenu.*
- ↵ *Select the Node ID menu item.*
- ↵ *Enter an address between 1 and 127.*
- ↵ *Save the address with save.*
- ↵ *Deactivate parameter enable.*

**Note!**

Basic operation of the display is described in Chapter 8. To set the address, parameter enable must be activated.

**Attention!**

The laser measurement system is deactivated on the CANopen if parameter enable is activated e.g. for address assignment.

If the AMS 335*i* is connected directly in the trunk line and networked with other participants via Bus Out, these participants also remain active after activation of parameter enable.

After cancelation of parameter enable, the AMS 335*i* is active again on the CANopen.

9.3 Baud rate setting

The AMS 335*i* supports the following baud rates:

- 1 Mbit/s
- 800 kbit/s
- 500 kbit/s
- 250 kbit/s
- **125 kbit/s**
- 50 kbit/s
- 20 kbit/s

The AMS 335*i* is set to 125 kbit/s by default.

The "Layer Setting Services (LSS)" function is not supported by the AMS 335*i*. The baud rate must be set manually via the display of the AMS.

9.3.1 Entering baud rate via display/panel

To enter the baud rate via the display/panel, proceed as follows:

- ↳ *Activation of parameter enable*
- ↳ *Select the CANopen submenu.*
- ↳ *Select the Baud rate menu item.*
- ↳ *Activate the desired baud rate.*
- ↳ *Deactivate parameter enable.*



Note!

Basic operation of the display is described in Chapter 8. To set the baud rate, parameter enable must be activated.



Attention!

The laser measurement system is deactivated on the CANopen if parameter enable is activated e.g. for baud rate setting.

*If the AMS 335*i* is connected directly in the trunk line and networked with other participants via Bus Out of the AMS, these participants also remain active after activation of parameter enable.*

*After cancelation of parameter enable, the AMS 335*i* is active again on the CANopen.*

9.4 CANopen electrical connection



BUS IN (5-pin connector, A-coded)		
Pin	Name	Comment
1	Drain	Shield
2	NC	Not assigned
3	NC	Not assigned
4	CAN_H	Data signal CAN_H
5	CAN_L	Data signal CAN_L
Thread	FE	Functional earth (housing)

BUS OUT (5-pin socket, A-coded)		
Pin	Name	Comment
1	Drain	Shield
2	NC	Not assigned
3	NC	Not assigned
4	CAN_H	Data signal CAN_H
5	CAN_L	Data signal CAN_L
Thread	FE	Functional earth (housing)

Figure 9.1: CANopen - Electrical connection

If the laser measurement system is the last subscriber in the network, the **BUS OUT** connection must be connected to a terminator plug; see "Accessories – Terminating resistor" on page 97.



Note!

For connecting **BUS IN** and **BUS OUT**, we recommend our ready-made CANopen cables (see chapter 11.3.6 "Accessory ready-made cables for CANopen").

9.5 Communication mechanisms of AMS 335/i on CAN

In a CANopen network, all participants have in principle equal privileges. Each participant can initiate its data transmission independently. Here, the arbitration specified by the CIA controls the access of the individual participants to the network. Generally, each CAN participant listens in on the bus. The transmission process is started only if the bus is not occupied by another CAN participant. When transmitting, the current bus status is always compared to the own transmitted frame.

If several participants start a transmission simultaneously, the arbitration process decides which participant gains access to the network next. The individual participants are integrated into a prioritization scheme via their bus address and the type of data to be transmitted (index address of the data). Process data (PDOs) of a device is transmitted with a higher priority than, for example, the variable objects (SDOs) of a device.

The node address of the participant is another criterion for prioritizing a participant in the network. The smaller the node address is, the higher the priority of the participants in the network will be.

Since every participant compares its own priority with that of the other participants at the time of bus access, the participants with low priority discontinue their transmission activities immediately. The participant with the highest priority obtains temporary access to the bus. The arbitration process controls the access of all participants so that even participants with a low priority have access to the bus.

9.5.1 Device profile of AMS 335/i

CANopen describes the characteristics of participants in so-called profiles. The AMS 335/i communicates in accordance with the specifications in the profile "DS406" Class 1.

The profile defines access to an absolute linear encoder.

The AMS 335/i is designed as a slave participant and cannot take on master functionality.

9.5.2 Object directories

All process data and parameters are stored as objects in the AMS 335/i. The object directory of the AMS 335/i is the compilation of all process data and parameters of the AMS.

An object directory is structured such that some objects within a device profile (DS406 in the case of the AMS 335/i) are mandatory while others are freely definable and stored in the manufacturer-specific object area.

The objects are uniquely identified using an index addressing scheme. The structure of the object directory, the assignment of the index numbers, as well as some mandatory entries are specified in the CIA standard DS301 for CANopen.

9.5.3 EDS file

For the user, the object directory of the AMS 335*i* is stored as an EDS file (Electronic Data Sheet).

The EDS file contains all objects with index, sub-index, name, data type, default value, minimum and maximum, and access privileges.

The EDS file describes the complete functionality of the AMS 335*i*.

9.5.4 SDOs and PDOs

The data exchange in CANopen distinguishes between service data objects (SDOs), which are used for transmitting the service data (parameters) from and to the object directory, and process data objects (PDOs), which are used to exchange the current process states.

9.5.4.1 SDOs

By using SDOs, all entries of the object directory can be accessed. Within one SDO call, only one object can be accessed at any one time. For this reason, a service data telegram must have a protocol structure which describes the exact target address by means of index and sub-index addressing. SDO telegrams place a part of the SDO addressing into the user data area. Eventually, a user data area with a width of 4 bytes out of the possible 8 bytes of user data remains for each SDO telegram.

The target address always responds to SDO transfers.

The index and sub-index address of the AMS 335*i* parameters and variables can be found below in the individual object descriptions.

9.5.4.2 PDOs

PDOs are objects (data, variables and parameters) from the object directory compiled (mapped) by the device manufacturer. A maximum of 8 bytes of user data from various objects can be mapped into one PDO.

A PDO can be received and evaluated by each participant (node). The model is referred to as the producer-consumer procedure.

Since there is no protocol structure in the telegram of a PDO, the participants in the network for whom these data are intended must know how the user data in the data area of the PDO are structured (which data are stored where in the user data area).

The exchange of process data is supported by the AMS 335/ via the following accesses:

- Event-controlled data transfer
Here, the data of a node are transmitted as a message whenever a change to the present state occurs.
- Polling with remote frames
The CAN node which has been defined as master in the network requests the desired information via query (via remote frame). The participant which has this information (or the required data) responds by sending the requested data.
- Synchronized mode
CANopen permits simultaneous querying of inputs and states of different participants and the simultaneous change of outputs or states. For this purpose, one uses the synchronization telegram (SYNC) transmitted by a master.
The SYNC telegram is a broadcast to all network devices with high priority and without data content. Generally, the master sends the SYNC telegram cyclically.
Participants working in synchronized mode read out their data when receiving the SYNC message and then transmit this data immediately afterwards as soon as the bus permits this (see explanation regarding arbitration process).
As the SYNC process can very quickly lead to high bus loads, another distinction is made between "event-controlled synchronization" and a "timer synchronization".
- Time-controlled transmission
In this case, the transmission of a PDO is triggered when an adjustable time period has elapsed. The time-controlled transmissions are set individually for each PDO via the so-called "inhibit time" or an "event timer". The respective parameters can be found in the objects 1800_h to 1803_h for the corresponding PDOs.
- Node monitoring
Heartbeat and guarding mechanisms are available for failure monitoring of the AMS 335/. This is particularly important for CANopen, as the AMS 335/ may not respond regularly in the event-controlled operating mode. In the case of guarding, the participants are cyclically queried for their state via data request telegrams (remote frame). In case of heartbeat, the nodes transmit their state themselves.
Heartbeat and guarding / life time are standard communication objects from the DS301 CANopen specification. The corresponding objects here are:
 - Heartbeat 1017_h
 - Guarding / Life time factor 100C_h and 100D_h

9.5.5 Default 11 bit identifier

The AMS 335*i* sends an 11-bit identifier. 29-bit identifiers can be neither received nor sent by the AMS 335*i*.

The node address (address of the AMS 335*i*) is part of the 11-bit identifier. The default identifier and the node address give the COB ID, the value of which defines the prioritization in the arbitration.



Note!

Low-value identifiers have a higher priority in the arbitration.

Example:

If the same objects are queried in a CANopen network consisting of multiple AMS 335*i* devices, e.g. PDO1 (rx), then the AMS with the smallest node address has the highest priority in the arbitration.

The table below shows the value of the individual functions in the arbitration process of the CANopen.

According to the table, synchronization and emergency objects have the highest priority. This is followed by the PDOs; at the end of the prioritization are the SDOs.

11 bit identifier (binary)	Identifier decimal	Identifier hexadecimal	Function
00000000000	0	0	Network management
00010000000	128	80	Synchronization
0001xxxxxxx	129 - 255	81 - FF	Emergency
0011xxxxxxx	385 - 511	181 - 1FF	PDO1 (tx)
0100xxxxxxx	513 - 639	201 - 27F	PDO1 (rx)
0101xxxxxxx	641 - 767	281 - 2FF	PDO2 (tx)
0110xxxxxxx	769 - 895	301 37F	PDO2 (rx)
0111xxxxxxx	897 - 1023	381 - 3FF	PDO3 (tx)
1000xxxxxxx	1025 - 1151	401 - 47F	PDO3 (rx)
1001xxxxxxx	1153 - 1279	481 - 4FF	PDO4 (tx)
1010xxxxxxx	1281 - 1407	501 - 57F	PDO4 (rx)
1011xxxxxxx	1409 - 1535	581 - 5FF	Send SDO
1100xxxxxxx	1537 - 1663	601 - 67F	Receive SDO
1110xxxxxxx	1793 - 1919	701 - 77F	NMT Error Control
xxxxxxx = node address 1 - 127			

9.5.6 Object structure of AMS 335/

Overview of CANopen-specific object area of AMS 335/

The following overview table shows the CANopen-specific communication objects from DS301 which are supported by the AMS 335/. The manual describes only the objects for which AMS 335/-specific configurations can be performed. All other objects are standard objects of the CANopen specification. A description of these objects can be found in the DS301.

Object address in hex	CANopen-specific object area
1000	Device type
1001	Error register
100C	Guard time
100D	Life-time factor
1017	Producer heartbeat time (necessary for heartbeat mechanism)
1018	Identity object (contains general information regarding the device)
1800	PDO 1 properties (position value and status asynchronous)
1801	PDO 2 properties (position value and status synchronous)
1802	PDO 3 properties (velocity value and status asynchronous)
1803	PDO 4 properties (velocity value and status synchronous)
1A00	TPDO 1 position value and status asynchronous
1A01	TPDO 2 position value and status synchronous
1A02	TPDO 3 velocity value and status asynchronous
1A03	TPDO 4 velocity value and status synchronous

Overview of manufacturer-specific object area of AMS 335/

Object address in hex	AMS 335/-specific object area
2000	Position value
2001	Static preset
2002	Dynamic preset
2010	Position limit value 1
2011	Position limit value 2
2020	Velocity
2021	Velocity limit value 1
2022	Velocity limit value 2
2023	Velocity limit value 3
2024	Velocity limit value 4
2025	Dynamic velocity limit value
2026	Velocity status
2050	I/O 1
2051	I/O 2
2060	Laser status and control ON/OFF
2070	Error handling procedures
2300	Other

Overview of encoder-specific object area of AMS 335/

Object address in hex	Objects of AMS 335/ from encoder profile DS406 Class 1
6000	Operating parameters
6004	Position value
6500	Operating status
6501	Measurement value resolution

9.5.7 Detailed description of CANopen-specific object area

9.5.7.1 Object 1000_h Device type

The object describes the AMS 335/*i* device type.

Index (hex)	Sub-index (hex)	Name	Data type	Access	Value range			Comment
					Minimum	Maximum	Default	
1000	--	Device type	u32	ro	--	--	00080196h	Device profile 196 _h Encoder type 8 _h

Data structure of object

Byte	Bit								Comment
	7	6	5	4	3	2	1	0	
0	196 _h								Device profile (196 _h)
1									
2	8 _h								Encoder type (8 _h)
3									

Device profile

The classification 196_h = 406_d describes the profile of an encoder. The AMS 335/*i* is thus integrated in the profile definition of an encoder.

The AMS 335/*i* is a Class 1 encoder in accordance with profile 406_d

Encoder

The classification 8_h = 8_d describes the AMS 335/*i* as an absolute, linear encoder

9.5.7.2 Object 1001_h Error register

This object contains the error register for the AMS 335/*i*. The AMS 335/*i* maps the internal ERR error (see Object 2060 Status and control) in this byte to bit 0.

Bit 0 is set as soon as error "ERR" of the AMS 335/*i* is pending, or if e.g. initialization of the AMS 335/*i* fails.

Index (hex)	Sub-index (hex)	Name	Data type	Access	Value range			Comment
					Minimum	Maximum	Default	
1001	--	Error register	u8	ro	--	--	0	--

Data structure of object

Byte	Bit								Comment
	7	6	5	4	3	2	1	0	
0	x	x	x	x	x	x	x	0	Error register

9.5.7.3 Object 100C_h Guard time

This object is used to configure the device monitoring by the NMT master (node guarding) together with the life time factor. The monitoring time is specified in milliseconds. If 0 is entered (default of the AMS 335*i*), the process is deactivated.

Index (hex)	Sub-index (hex)	Name	Data type	Access	Value range			Comment
					Minimum	Maximum	Default	
100C	--	Guard time	u16	rw	0	65535	0	Guard time is deactivated by default 0

9.5.7.4 Object 100D_h Life time factor

This object must be viewed in connection with object 100C_h. When multiplied by the guard time, this value gives the life time.

If 0 is entered (default of the AMS 335*i*), the process is deactivated.

Index (hex)	Sub-index (hex)	Name	Data type	Access	Value range			Comment
					Minimum	Maximum	Default	
100D	--	Life time	u 8	rw	0	255	0	Life time is deactivated by default 0

9.5.7.5 Object 1017_h Producer heartbeat time

This object defines the cycle time in milliseconds at which heartbeat messages are sent from the AMS 335*i* into the CANopen network. If the producer heartbeat time is not used, it is set to the value 0 (zero). By default, the time is set to 0 (zero) on the AMS 335*i*. As a result, the AMS 335*i* does not send a cyclical heartbeat signal.

Index (hex)	Sub-index (hex)	Name	Data type	Access	Value range			Comment
					Minimum	Maximum	Default	
1017	--	Producer heartbeat time	u16	rw	0	65536	0	Producer heartbeat time is deactivated with default 0

9.5.7.6 Object 1018_h Identity object

This object contains general specifications about the AMS 335*i*.

Index (hex)	Sub-index (hex)	Name	Data type	Access	Value range			Comment
					Minimum	Maximum	Default	
1018	01	Vendor ID	u 32	ro	--	--	121 _h	Manufacturer ID number
	02	Product code	u 32	ro	--	--	02 _h	Product designation

9.5.7.7 Objects 1800_h - 1803_h Communication parameters of process data objects (PDOs)

9.5.7.8 Objects 1A00_h - 1A03_h Process data objects TPDOs

The AMS 335*i* provides four transmit process data objects (TPDOs).

The TPDOs describe which objects are mapped to (integrated in) the TxPDO, and define the access (synchronous/asynchronous) to these objects.

- TPDO1 Position value and status asynchronous, object address 1A00_h
- TPDO2 Position value and status synchronous, object address 1A01_h
- TPDO3 Velocity value and status asynchronous, object address 1A02_h
- TPDO4 Velocity value and status synchronous, object address 1A03_h

The communication parameters of the PDOs are determined via defined objects.

Synchronous or asynchronous access, a possible inhibit time for the PDO object in the CAN network as well as an event timer are defined in these objects.

- PDO1 Communication parameter for position value and status asynchronous, object address 1800_h
- PDO2 Communication parameter for position value and status synchronous, object address 1801_h
- PDO3 Communication parameter for velocity value and status asynchronous, object address 1802_h
- PDO4 Communication parameter for velocity value and status synchronous, object address 1803_h

Asynchronous transmission (TPDO1 and TPDO3) is controlled by the event timer in the PDOx property objects 1800_h and 1803_h.

Synchronous transmission (TPDO2 and TPDO4) is initiated by a SYNC telegram (80_h) sent from the master, as well as by the PDOx property objects 1801_h to 1803_h.

9.5.7.9 Object 1800_h PDO1

Communication parameter for asynchronous transmission of position and status.

Index (hex)	Sub-index (hex)	Name	Data type	Access	Value range			Comment
					Minimum	Maximum	Default	
1800	01	COB-ID for TPDO1	u 32	ro	--	--		180h + Node ID
	02	Transmission type	u 8	rw	--	--	254	254 = asynchronous
	03	Inhibit time	u 16	rw	0	1000	0	Inhibit time
	04	Reserve						
	05	Event timer	u 16	rw	0	65535	0	Event timer



Attention!

The inhibit timer can only be written if the PDO was set to "PDO invalid" beforehand. This is done by setting bit 31 of the COB ID for the respective PDO to 1, setting the inhibit time to the desired time and then setting bit 31 back to 0 (= PDO valid). This applies to all 4 PDOs!

9.5.7.10 Object 1A00_h TPDO1

Asynchronous transmission of position and status.

Index (hex)	Sub-index (hex)	Name	Data type	Access	Value range			Comment
					Minimum	Maximum	Default	
1A00	01	Position value	u 32	ro	--	--	6004 00 20	Position value from object 6004
	02	Position value status	u 32	ro	--	--	2060 01 20	Status from object 2060

Data structure of TPDO1 for asynchronous transmission of position values and position status

Byte	Bit								Comment
	7	6	5	4	3	2	1	0	
0								LSB	Position values See object description 6004 _h
1									
2									
3	MSB								
4									Status See object description 2060 _h , Sub-index 01
5									
6									
7									

9.5.7.11 Object 1801_h PDO2

Communication parameters for synchronous transmission of position and status

Index (hex)	Sub-index (hex)	Name	Data type	Access	Value range			Comment
					Minimum	Maximum	Default	
1801	01	COB-ID for TPDO1	u 32	ro	--	--		280h + Node ID
	02	Transmission type	u 8	rw	--	--	1	1 = cyclical + synchronous
	03	Inhibit time	u 16	rw	0	1000	0	Inhibit time
	04	Reserve						
	05	Event timer	u 16	rw	0	65535	0	Event timer

9.5.7.12 Object 1A01_h TPDO2

Synchronous transmission of position and status

Index (hex)	Sub-index (hex)	Name	Data type	Access	Value range			Comment
					Minimum	Maximum	Default	
1A01	01	Position value	u 32	ro	--	--	6004 00 20	Position value from object 6004
	02	Position value status	u 32	ro	--	--	2060 01 20	Status from object 2060

Data structure of TPDO2 for synchronous transmission of position value and position status

Byte	Bit								Comment
	7	6	5	4	3	2	1	0	
0								LSB	Position data See object description 6004 _h
1									
2									
3	MSB								
4									Status See object description 2060 _h . Sub-index 01
5									
6									
7									

9.5.7.13 Object 1802_h PDO3

Communication parameter for asynchronous transmission of velocity and status.

Index (hex)	Sub-index (hex)	Name	Data type	Access	Value range			Comment
					Minimum	Maximum	Default	
1803	01	COB-ID for TPDO1	u 32	ro	--	--		380h + Node ID
	02	Transmission type	u 8	rw	--	--	254	254 = asynchronous
	03	Inhibit time	u 16	rw	0	1000	0	Inhibit time
	04	Reserve						
	05	Event timer	u 16	rw	0	1000	0	Event timer

9.5.7.14 Object 1A02_h

TPDO3 Asynchronous transmission of velocity and status.

Index (hex)	Sub-index (hex)	Name	Data type	Access	Value range			Comment
					Minimum	Maximum	Default	
1A02	01	Velocity value	int 32	ro	--	--	2020 04 20	Velocity value from object 2020 Sub-index 04
	02	Velocity value status	u 16	ro	--	--	2026 00 10	Status from object 2026

Data structure of TPDO3 for asynchronous transmission of velocity values and velocity status

Byte	Bit								Comment
	7	6	5	4	3	2	1	0	
0								LSB	Velocity value See object description 2020 _h Sub-index 04
1	MSB								
2									Status See object description 2026 _h Sub-index 01
3									

9.5.7.15 Object 1803_h, PDO4

Communication parameter for synchronous transmission of velocity and status.

Index (hex)	Sub-index (hex)	Name	Data type	Access	Value range			Comment
					Minimum	Maximum	Default	
1804	01	COB-ID for TPDO1	u 32	ro	--	--		480h + Node ID
	02	Transmission type	u 8	rw	--	--	1	1 = synchronous + cyclical
	03	Inhibit time	u 16	rw	0	1000	0	Inhibit time
	04	Reserve						
	05	Event timer	u 16	rw	0	65535	0	Event timer

9.5.7.16 Object 1A03_h

TPDO4 Synchronous transmission of velocity and status.

Index (hex)	Sub-index (hex)	Name	Data type	Access	Value range			Comment
					Minimum	Maximum	Default	
1A03	01	Velocity value	int 16	ro	--	--	2020 04 20	Velocity value from object 2020 Sub-index 04
	02	Velocity value status	u 16	ro	--	--	2026 00 10	Status from object 2026

Data structure of TPDO4 for synchronous transmission of velocity value and velocity status

Byte	Bit								Comment
	7	6	5	4	3	2	1	0	
0								LSB	Velocity value See object description 2020 _h Sub-index 04
1	MSB								
2									Status
3									See object description 2026 _h Sub-index 01

9.5.8 AMS 335_i-specific object area

9.5.8.1 Object 2000_h Position value

The position value object describes the following entries:

- Sign for negative position values
- Unit of the position value, metric or inch
- Resolution of the position value
- Counting direction of the position value
- Possible offset value
- Value for the free resolution

Index (hex)	Sub-index (hex)	Name	Data type	Access	Value range			Comment
					Minimum	Maximum	Default	
2000	01	Sign	u 8	rw	0	1	0	0 = Two's complement 1 = Sign + magnitude
	02	Unit	u 8	rw	0	1	0	0 = Metric 1 = Inch (in)
	03	Resolution	u 8	rw	0	6	4	Value 1 = 0.001 Value 2 = 0.01 Value 3 = 0.1 Value 4 = 1 Value 5 = 10 Value 6 = free resolution

Index (hex)	Sub-index (hex)	Name	Data type	Access	Value range			Comment
					Minimum	Maximum	Default	
	04	Counting direction	u 8	rw	0	1	0	0 = Positive 1 = Negative See below for further comments
	05	Offset value	int 32	rw	-999999	999999	0	See comments below
	06	Value for free resolution	u 16	rw	5	50000	1000	See comments below

Sub-index 03 Resolution

Resolution in mm or inch/100 depending on selected unit.

The value for the free resolution must be set in index 06.

Sub-index 04 Counting direction



Attention!

Encoder specification DS406 specifies that the counting direction can be set in object 6000 bit 3. Object 2000 sub-index 04 and object 6000 bit 3 overwrite each other.

The counting direction changes the sign during velocity measurement.

An appropriate offset must be selected such that only positive values are transmitted.

Counting direction positive:

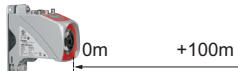

Counting direction negative:

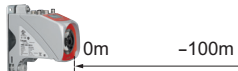

Sub-index 05 Offset value

Offset value in mm or inch/100 depending on selected unit.

Output value = measurement value + offset.

If the preset value is activated by a corresponding trigger signal, the preset value has priority over the offset value.

The preset value and offset value are not offset against each other. The resolution of the offset value is independent of the resolution selected for the position value. The offset value is immediately active without any further release.

Sub-index 06 Free resolution

Free resolution in mm/1000 or inch/100000 depending on the selected unit.

The "free resolution" parameters from sub-index 03 and the "free resolution" value from sub-index 06 are mutually dependent. The value of the free resolution is multiplied in mm/1000 or inch/100000 depending on the selected unit. The product of multiplication is then the set free resolution.

9.5.8.2 Object 201_h Static preset value

The static preset value is a parameter that is no longer changed after the system has been handed over to the end operating company. It is configured during commissioning and then remains unchanged.

A preset value can be entered in the object. The preset value is activated by "preset teach" and deactivated with "preset reset". After preset teach, the current position value is offset against the configured preset value. After preset reset, the original measurement value is displayed.

Index (hex)	Sub-index (hex)	Name	Data type	Access	Value range			Comment
					Minimum	Maximum	Default	
2001	01	Preset value static	int 32	rw	-999999	999999	0	Preset value in mm or in/100 depending on selected unit
	02	Preset settings	u 8	rw	0	2	0	Value 1 = Preset teach Value 2 = Preset reset

9.5.8.3 Object 202_h Dynamic preset value

The dynamic preset value can be adapted permanently by the control.

The dynamic preset value is activated by "preset teach" and deactivated with "preset reset". After preset teach, the current position value is offset against the configured preset value. After preset reset, the original measurement value is displayed.

Index (hex)	Sub-index (hex)	Name	Data type	Access	Value range			Comment
					Minimum	Maximum	Default	
2002	01	Preset value static	int 32	rw	-999999	999999	0	Preset value in mm or in/100 depending on selected unit
	02	Preset settings	u 8	rw	0	2	0	Value 1 = Preset teach Value 2 = Preset reset

9.5.8.4 Object 2010_h Position limit value range 1

The "Position limit value range 1" object defines a distance range with lower and upper limit. If the measured value is outside the configured range, the corresponding status bits are set in the objects 2050_h, 2051_h and 2060_h.

Index (hex)	Sub-index (hex)	Name	Data type	Access	Value range			Comment
					Minimum	Maximum	Default	
2010	01	Release of position limit value 1	u8	rw	0	1	0	0 = Deactivated 1 = Activated
	02	Lower position limit value 1	int 32	rw	-999999	999999	0	See comments below
	03	Upper position limit value 1	int 32	rw	-999999	999999	0	See comments below

Sub-index 02_n / sub-index 03_n

The lower and upper position limit values are entered in mm or inch/100 depending on the selected unit.

9.5.8.5 Object 2011_n, Position limit value range 2

The "Position limit value range 2" object defines a distance range with lower and upper limit. If the measured value is outside the configured range, the corresponding status bits are set in the objects 2050_n, 2051_n, and 2060_n.

Index (hex)	Sub-index (hex)	Name	Data type	Access	Value range			Comment
					Minimum	Maximum	Default	
2011	01	Release of position limit value 2	u8	rw	0	1	0	0 = Deactivated 1 = Activated
	02	Lower position limit value 2	int 32	rw	-999999	999999	0	See comments below
	03	Upper position limit value 2	int 32	rw	-999999	999999	0	See comments below

Sub-index 02_n / sub-index 03_n

The lower and upper position limit values are entered in mm or inch/100 depending on the selected unit.

9.5.8.6 Object 2020_n, Velocity

Outputs the current velocity with the configured resolution. The unit (metric or inch) is set in object 2000 sub-index 02 and also applies to the velocity. If no change is made in object 2000 sub-index 02, the AMS 335/ uses the default setting "metric".

The sign of the velocity is dependent on the counting direction in object 2000 sub-index 04.

In the default setting, a positive velocity is output when the reflector moves away from the AMS 335*i*. When the reflector moves toward the AMS 335*i*, negative velocities are output. If the "negative" counting direction is configured in object 2000 sub-index 04, the velocity sign is reversed.

The response time for the velocity averages all calculated velocity values over the set time to form one velocity value. This averaged velocity value is output via the interface.

Index (hex)	Sub-index (hex)	Name	Data type	Access	Value range			Comment
					Minimum	Maximum	Default	
2020	01	Velocity resolution	u8	rw	1	5	1	Value 1: = 1 Value 2: = 10 Value 3: = 100 Value 4: = 1000 Value 5: = free resolution
	02	Response time for velocity	u8	rw	0	6	3	Unit ms Value 0: = 2 Value 1: = 4 Value 2: = 8 Value 3: = 16 Value 4: = 32 Value 5: = 64 Value 6: = 128
	03	Free velocity resolution	u16	rw	5	50000	1000	The configured value is multiplied in mm/1000/s or in/100000/s.
	04	Velocity value	int 32	ro	-999999	999999	--	See below

The velocity value is mapped to process data objects 1A02_h and 1A03_h.

Sub-index 01_h

The current velocity is output with the configured resolution. The unit (metric or inch) is set in object 2000 sub-index 02 and also applies to the velocity.

9.5.8.7 Object 2021_h Configuration of velocity monitoring 1

Objects 2021_h to 2024_h enable comparison of the velocity currently measured by the AMS 335*i*, with a limit value stored in the respective object.



Note!

Note regarding velocity monitoring 1 - 4 and dynamic velocity monitoring

*If **position start** and **position end** are identical, velocity monitoring is active over the entire traversing range.*

If a direction-dependent limit value check is activated via the **Direction selection** parameter, the values of **position start** and **position end** also define the direction. The check is always performed from **position start** to **position end**. For example, if the range start is "5500" and

the range end is "5000", the direction-dependent check is only performed in the direction from "5500" to "5000". The limit value is not active in the opposite direction.

If the check is independent of direction, the order of **position start** and **position end** is irrelevant. Depending on the selected **switching type**, if the value is above or below the defined limits, the limit value status in object 2026h is set and, if configured, the switching output is set via object 2050_h or 2051_h.



Note!

The explanations given above regarding the "position start" and "position end" parameters apply analogously to objects 2022_h to 2025_h.

Index (hex)	Sub-index (hex)	Name	Data type	Access	Value range			Comment
					Minimum	Maximum	Default	
2021	01	Limit value check	u8	rw	0	7	0	See below
	02	Velocity limit value 1	u16	rw	0	20000	0	mm/s or (in/100)/s
	03	Hysteresis of velocity limit value 1	u16	rw	0	20000	100	mm/s or (in/100)/s
	04	Monitoring as of position start	int 32	rw	-999999	999999	0	mm or in/100
	05	Monitoring up to position end	int 32	rw	-999999	999999	0	mm or in/100

Sub-index 01

Bit 0: Switching type

- 0 = Velocity above upper limit
- 1 = Velocity below lower limit

Bit 1: Direction selection

- 0 = Velocity monitoring not direction-dependent
- 1 = Velocity monitoring direction-dependent

Bit 2: Velocity monitoring

- 0 = Deactivated
- 1 = Activated

Bit 3 - Bit 7: Reserve

9.5.8.8 Object 2022_h Configuration of velocity monitoring 2



Note!

For further explanations regarding the position start and position end parameters, see chapter 9.5.8.7 "Object 2021_h Configuration of velocity monitoring 1".

Index (hex)	Sub-index (hex)	Name	Data type	Access	Value range			Comment
					Minimum	Maximum	Default	
2022	01	Limit value check	u 8	rw	0	7	0	See below
	02	Velocity limit value 1	u 16	rw	0	20000	0	mm/s or (in/100)/s
	03	Hysteresis of velocity limit value 1	u 16	rw	0	20000	100	mm/s or (in/100)/s
	04	Monitoring as of position start	i 32	rw	-999999	999999	0	mm or in/100
	05	Monitoring up to position end	i 32	rw	-999999	999999	0	mm or in/100

Sub-index 01

Bit 0: Switching type

- 0 = Velocity above upper limit
- 1 = Velocity below lower limit

Bit 1: Direction selection

- 0 = Velocity monitoring not direction-dependent
- 1 = Velocity monitoring direction-dependent

Bit 2: Velocity monitoring

- 0 = Deactivated
- 1 = Activated

Bit 3 - Bit 7: Reserve

9.5.8.9 Object 2023_h Configuration of velocity monitoring 3



Note!

For further explanations regarding the position start and position end parameters, see chapter 9.5.8.7 "Object 2021_h Configuration of velocity monitoring 1".

Index (hex)	Sub-index (hex)	Name	Data type	Access	Value range			Comment
					Minimum	Maximum	Default	
2023	01	Limit value check	u 8	rw	0	7	0	See below
	02	Velocity limit value 1	u 16	rw	0	20000	0	mm/s or (in/100)/s
	03	Hysteresis of velocity limit value 1	u 16	rw	0	20000	100	mm/s or (in/100)/s.
	04	Monitoring as of position start	int 32	rw	-999999	999999	0	mm or in/100
	05	Monitoring up to position end	int 32	rw	-999999	999999	0	mm or in/100

Sub-index 01

Bit 0: Switching type

- 0 = Velocity above upper limit
- 1 = Velocity below lower limit

Bit 1: Direction selection

- 0 = Velocity monitoring not direction-dependent
- 1 = Velocity monitoring direction-dependent

Bit 2: Velocity monitoring

- 0 = Deactivated**
- 1 = Activated

Bit 3 - Bit 7: Reserve

9.5.8.10 Object 2024_h Configuration of velocity monitoring 4



Note!

For further explanations regarding the position start and position end parameters, see chapter 9.5.8.7 "Object 2021_h Configuration of velocity monitoring 1".

Index (hex)	Sub-index (hex)	Name	Data type	Access	Value range			Comment
					Minimum	Maximum	Default	
2024	01	Limit value check	u 8	rw	0	7	0	See below
	02	Velocity limit value 1	u 16	rw	0	20000	0	mm/s or (in/100)/s
	03	Hysteresis of velocity limit value 1	u 16	rw	0	20000	100	mm/s or (in/100)/s.
	04	Monitoring as of position start	int 32	rw	-999999	999999	0	mm or in/100
	05	Monitoring up to position end	int 32	rw	-999999	999999	0	mm or in/100

Sub-index 01

Bit 0: Switching type

- 0 = Velocity above upper limit
- 1 = Velocity below lower limit

Bit 1: Direction selection

- 0 = Velocity monitoring not direction-dependent
- 1 = Velocity monitoring direction-dependent

Bit 2: Velocity monitoring

- 0 = Deactivated
- 1 = Activated

Bit 3 - Bit 7: Reserve

9.5.8.11 Object 2025_h Configuration of dynamic velocity monitoring



Note!

For further explanations regarding the position start and position end parameters, see chapter 9.5.8.7 "Object 2021_h Configuration of velocity monitoring 1".

Index (hex)	Sub-index (hex)	Name	Data type	Access	Value range			Comment
					Minimum	Maximum	Default	
2025	01	Limit value check	u 8	rw	0	7	0	See below
	02	Velocity limit value 1	u 16	rw	0	20000	0	mm/s or (in/100)/s
	03	Hysteresis of velocity limit value 1	u 16	rw	0	20000	100	mm/s or (in/100)/s.
	04	Monitoring as of position start	int 32	rw	-999999	999999	0	mm or in/100
	05	Monitoring up to position end	int 32	rw	-999999	999999	0	mm or in/100

Sub-index 01

Bit 0: Switching type

- 0 = Velocity above upper limit
- 1 = Velocity below lower limit

Bit 1: Direction selection

- 0 = Velocity monitoring not direction-dependent
- 1 = Velocity monitoring direction-dependent

Bit 2: Velocity monitoring

- 0 = Deactivated
- 1 = Activated

Bit 3 - Bit 7: Reserve

9.5.8.12 Object 2026_n Velocity status

Index (hex)	Sub-index (hex)	Name	Data type	Access	Value range			Comment
					Minimum	Maximum	Default	
2026	--	Velocity status	u 16	ro	--	--	--	See below

Bit 0: Velocity measurement error

- 0 = OK
- 1 = Error

Bit 1: Movement status

- 0 = No movement
- 1 = Movement

Bit 2: Movement status

- 0 = Positive direction
- 1 = Negative direction

Bit 3: Velocity limit value status 1

- 0 = Limit value observed
- 1 = Limit value violated

Bit 4: Velocity limit value status 2

- 0 = Limit value observed
- 1 = Limit value violated

Bit 5: Velocity limit value status 3

- 0 = Limit value observed
- 1 = Limit value violated

Bit 6: Velocity limit value status 4

- 0 = Limit value observed
- 1 = Limit value violated

Bit 7: Velocity limit value status dynamic

- 0 = Limit value observed
- 1 = Limit value violated

Bit 8: Velocity comparison – limit value 1

- 0 = Comparison not active
- 1 = Comparison active

Bit 9: Velocity comparison – limit value 2

- 0 = Comparison not active
- 1 = Comparison active

Bit 10: Velocity comparison – limit value 3

- 0 = Comparison not active
- 1 = Comparison active

Bit 11: Velocity comparison – limit value 4

- 0 = Comparison not active
- 1 = Comparison active

Bit 12: Velocity comparison – dynamic limit value

- 0 = Comparison not active
- 1 = Comparison active

9.5.8.13 Object 2050_h, Configuration of I/O 1

Index (hex)	Sub-index (hex)	Name	Data type	Access	Value range			Comment
					Minimum	Maximum	Default	
2050	--	I/O1	u 32	rw	--	--	--	See below

The settings in "bold" are the default settings

Bit 0: Function of I/O 1 connection on PWR M12

- 0 = Input
- 1 = Output**

Bit 1: activation

If I/O 1 is defined as input (see bit 0):

- 0 = 1 - 0 transition**
- 1 = 0 - 1 transition

If I/O 1 is defined as output (see bit 0):

- 0 = low active (the output is set to 0 if the event occurs)**
- 1 = high active (the output is set to 1 if the event occurs)

Bit 2 - Bit 7: Reserve

- 0 = Reserve**
- 1 = NC

**Note!**

Bit 8 to bit 23 affect the "OR" linked output.

Bit 8: Position limit value 1

If the position value is outside of configured limit value 1, the output is set.

- 0 = OFF**
- 1 = ON

Bit 9: Position limit value 2

If the position value is outside of configured limit value 2, the output is set.

- 0 = OFF**
- 1 = ON

Bit 10: Velocity limit value

If the velocity value is outside of the configured values, the output is set. The monitoring processes from objects 2021_h to 2025_h are "OR" linked to this bit.

- 0 = OFF**
- 1 = ON

Bit 11: Intensity monitoring (ATT)

If the intensity of the reception signal drops below the defined limit value, the output is set.

- 0 = OFF**
- 1 = ON

Bit 12: Temperature monitoring (TMP)

If the internal device temperature is outside the defined limit values, the output is set.

- 0 = OFF**
- 1 = ON

Bit 13: Laser prefailure monitoring (LSR)

If the laser power drops below the defined limit value, the output is set.

- 0 = OFF**
- 1 = ON

Bit 14: Plausibility monitoring (PLB)

If implausible measurement values are diagnosed, the output is set.

- 0 = OFF**
- 1 = ON

Bit 15: Hardware error (ERR)

If a hardware error is diagnosed, the output is set.

- 0 = OFF**
- 1 = ON

Bit 16 - Bit 23: Reserve

- 0 = Reserve**
- 1 = NC

Bit 24 - bit 26: Function of I/O 1 when defined as input

Value 000 = No function

Value 001 = Preset teach, valid for static (object 2001) and dynamic (object 2002) pre-set

Value 010 = Laser OFF; laser diode is switched off

Bit 27 - Bit 31: Reserve

- 0 = Reserve**
- 1 = NC

9.5.8.14 Object 2051_h Configuration of I/O 2

Index (hex)	Sub-index (hex)	Name	Data type	Access	Value range			Comment
					Minimum	Maximum	Default	
2051	--	I/O2	u32	rw	--	--	--	See below

The settings in "bold" are the default settings

Bit 0: Function of I/O 2 connection on PWR M12

- 0 = Input
- 1 = Output

Bit 1: activation

If I/O 2 is defined as input (see bit 0):

- 0 = 1 - 0 transition
- 1 = 0 - 1 transition

If I/O 2 is defined as output (see bit 0):

- 0 = low active (the output is set to 0 if the event occurs)
- 1 = high active (the output is set to 1 if the event occurs)

Bit 2 - Bit 7: Reserve

- 0 = Reserve
- 1 = NC

**Note!**

Bit 8 to bit 23 affect the "OR" linked output.

Bit 8: Position limit value 1

If the position value is outside of configured limit value 1, the output is set.

- 0 = OFF
- 1 = ON

Bit 9: Position limit value 2

If the position value is outside of configured limit value 2, the output is set.

- 0 = OFF
- 1 = ON

Bit 10: Velocity limit value

If the velocity value is outside of the configured values, the output is set. The monitoring processes from objects 2021_h to 2025_h are "OR" linked to this bit.

- 0 = OFF
- 1 = ON

Bit 11: Intensity monitoring (ATT)

If the intensity of the reception signal drops below the defined limit value, the output is set.

- 0 = OFF
- 1 = ON

Bit 12: Temperature monitoring (TMP)

If the internal device temperature is outside the defined limit values, the output is set.

- 0 = OFF
- 1 = ON

Bit 13: Laser prefailure monitoring (LSR)

If the laser power drops below the defined limit value, the output is set.

0 = OFF

1 = ON

Bit 14: Plausibility monitoring (PLB)

If implausible measurement values are diagnosed, the output is set.

0 = OFF

1 = ON

Bit 15: Hardware error (ERR)

If a hardware error is diagnosed, the output is set.

0 = OFF

1 = ON

Bit 16 - Bit 23: Reserve

0 = Reserve

1 = NC

Bit 24 - bit 26: Function of I/O 2 when defined as input

Value 000 = No function

Value 001 = Preset teach, valid for static (object 2001) and dynamic (object 2002) preset

Value 010 = Laser OFF; laser diode is switched off

Bit 27 - Bit 31: Reserve

0 = Reserve

1 = NC

9.5.8.15 Object 2060h AMS 335*i* status and control

The object makes the following status messages of the AMS 335*i* available in sub-index 01.

- Laser status ON/OFF
- Preset status ON/OFF
- Preset teach activated/not activated
- Monitoring of lower position limit value 1
- Monitoring of upper position limit value 1
- Monitoring of lower position limit value 2
- Monitoring of upper position limit value 2
- Intensity (ATT)
- Temperature (TMP)
- Laser (LSR)
- Plausibility (PLB)

In sub-index 02, the laser diode can be switched OFF/ON.

Index (hex)	Sub-index (hex)	Name	Data type	Access	Value range			Comment
					Minimum	Maximum	Default	
2060	01	Status	u32	ro	--	--	--	See below
	02	Laser ON/OFF	u8	rw	0	1	0	0 = Laser ON 1 = Laser OFF

Explanations regarding sub-index 01

Bit 0: Hardware error (ERR)

0 = OK

1 = Hardware error (ERR)

Bit 1 - Bit 3: Reserve

0 = Reserve

1 = NC

Bit 4: Monitoring of lower position limit value 1

0 = OK

1 = Value less than limit

Bit 5: Monitoring of upper position limit value 1

0 = OK

1 = Value greater than limit

Bit 6: Monitoring of lower position limit value 2

0 = OK

1 = Value less than limit

Bit 7: Monitoring of upper position limit value 2

0 = OK

1 = Value greater than limit

Bit 8: Laser status

0 = OK

1 = Laser OFF

Bit 9: Preset status

0 = Preset inactive

1 = Preset active

Bit 10: Preset teach (toggle bit)

This bit toggles with each teach event of a preset value

Bit 11 - Bit 12: Reserve

0 = Reserve

1 = NC

Bit 13: Intensity (ATT)

If the intensity of the reception signal drops below the defined limit value, the warning is set

- 0 = OK
- 1 = Warning

Bit 14: Temperature (TMP)

If the internal device temperature is outside the defined limit values, the warning is set.

- 0 = OK
- 1 = Warning

Bit 15: Laser (LSR)

If the laser power drops below the defined limit value, the warning is set.

- 0 = OK
- 1 = Warning

Bit 16: Plausibility (PLB)

If implausible measurement values are diagnosed, the error is set.

- 0 = OK
- 1 = Error

Bit 17 - Bit 31: Reserve

- 0 = Reserve
- 1 = NC

9.5.8.16 Object 2070_h Behavior of AMS 335*i* in case of failure

Index (hex)	Sub-index (hex)	Name	Data type	Access	Value range			Comment
					Minimum	Maximum	Default	
2070	01	Position value in case of failure and error delay ON/OFF	u8	rw	0	13	13	See below
	02	Position error message delay	u16	rw	100	1000	100	Error message delay time in ms
	03	Velocity value in case of failure and error delay ON/OFF	u8	rw	0	13	13	See below
	04	Error delay time (velocity)	u16	rw	200	1000	200	

Explanation regarding sub-index 01**Bit 0: Position value in case of failure**

0 = Last valid value
 1 = Zero

Bit 1: Static 0

Bit 2: Suppress position status
 0 = OFF
 1 = ON

Bit 3: Position error delay

0 = OFF
 1 = ON

Explanation regarding sub-index 03**Bit 0: Velocity value in case of failure**

0 = Last valid value
 1 = Zero

Bit 1: Static 0**Bit 2: Suppress velocity status**

0 = OFF
 1 = ON

Bit 3: Velocity error delay

0 = OFF
 1 = ON

9.5.8.17 Object 2300_h Other

Index (hex)	Sub-index (hex)	Name	Data type	Access	Value range			Comment
					Minimum	Maximum	Default	
2300	01	Display language selection	u8	rw	0	4	0	0 = English 1 = German 2 = Italian 3 = Spanish 4 = French

Index (hex)	Sub-index (hex)	Name	Data type	Access	Value range			Comment
					Minimum	Maximum	Default	
	02	Display illumination duration	u8	rw	0	1	0	0 = Off after 10min. 1 = Always on
	03	Display contrast	u8	rw	0	2	1	0 = Low 1 = Medium 2 = High
	04	Password activation	u8	rw	0	1	0	0 = OFF 1 = ON
	05	Password	u16	rw	0000	9999	0000	Setting of 4-digit password
	06	Heating control	u8	rw	0	1	0	See below



Note!

Password activation must be set to ON.

Explanation regarding sub-index 06 "Heating control"

- 0 = Standard (10°C ... 15°C)
- 1 = Extended (30°C ... 35°C)



Note!

*Sub-index 06 is available as standard, but functions only for devices with integrated heating (AMS 335*f* ... H).*

Sub-index 06 defines a switch-on/switch-off range for the heating control. The extended switch-on/switch-off range for heating may provide a remedy in the event of condensation problems. Due to the limited heating capacity, it cannot be guaranteed that no condensation will form on the optics in the extended switch-on/switch-off range.

9.5.9 Objects of AMS 335*f* from encoder profile DS406 Class 1

CANopen describes the characteristics of participants in so-called profiles.

The AMS 335*f* communicates in accordance with the specifications in the profile "DS406" Class 1.

For Class 1, it is essential to describe the following objects.

9.5.9.1 Object 6000_h Operating parameter

Index (hex)	Sub-index (hex)	Name	Data type	Access	Value range			Comment
					Minimum	Maximum	Default	
6000	--	Operating parameters	u16	rw	0	8	0	0= Positive counting direction, see below

Bit 0 - Bit 2

Not used

Bit 3: Counting direction

0 = Positive - The measurement value increases with increasing distance.

1 = Negative - The measurement value decreases with decreasing distance.

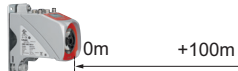
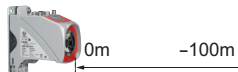
Counting direction positive:**Counting direction negative:****Bit 4 - Bit 15: Reserve****9.5.9.2 Object 6004_h Position value**

Index (hex)	Sub- index (hex)	Name	Data type	Access	Value range			Comment
					Minimum	Maximum	Default	
6004	--	Position value	int 32	ro	-999999	999999	--	See below

Object 6004_h contains the position value for process data objects (PDOs) 1A00_h (TPDO1) and 1A01_h (TPDO2).

Byte	Bit								Comment
	7	6	5	4	3	2	1	0	
0								LSB	Position value
1									
2									
3	MSB								

9.5.9.3 Object 6500_h Display of operating status from object 6000

Index (hex)	Sub- index (hex)	Name	Data type	Access	Value range			Comment
					Minimum	Maximum	Default	
6500	--	Operating parame- ters	u16	ro	--	--	--	See below

Bit 0 - Bit 2

Not used

Bit 3: Counting direction

0 = Positive - The measurement value increases with increasing distance.

1 = Negative - The measurement value decreases with decreasing distance.

Bit 4 - Bit 15: Reserve

9.5.9.4 Object 6501_h Measuring increment

Index (hex)	Sub-index (hex)	Name	Data type	Access	Value range			Comment
					Minimum	Maximum	Default	
6501	--	Measuring increments	u32	ro	--	--	--	See below

The resolution set in object 2000_h sub-index 03 is specified in object 6501 as a multiple of 0.001 μm (1 nm).

Example:

If the default resolution of 1 mm is set in object 2000_h, the resolution is converted to the value 1 000 000 for object 6501. (1 000 000 x 1/1 000 000 = 1).

10 Diagnostics and troubleshooting

10.1 Service and diagnosis in the display of the AMS 335*i*

In the main menu of the AMS 335*i*, expanded "Diagnostics" can be called up under the Service heading.

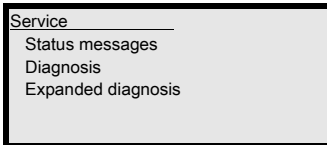

From the Service main menu, press the enter button (↵) to access the underlying menu level.

Use the up/down buttons (▲ ▼) to select the corresponding menu item in the selected level; use the enter button (↵) to activate the selection.

Return from any sub-level to the next-higher menu item by pressing the ESC button (⏏).

10.1.1 Status messages

The status messages are written in a ring memory with 25 positions. The ring memory is organized according to the FIFO principle. No separate activation is necessary for storing the status messages. Power OFF clears the ring memory.



Basic representation of the status messages

n: Type / No. / 1

Meaning:

n: memory position in the ring memory

Type: type of message:

I = info, W = warning, E = error, F = severe system error.

No: internal error detection

1: frequency of the event (always "1" because no summation occurs)

The status messages within the ring memory are selected with the up/down buttons (▲ ▼). Use the enter button (↵) to call up **detailed information** about the respective status message:

Detailed information about a status message

- Type:** type of message + internal counter
- UID:** Leuze-internal coding of the message
- ID:** description of the message
- Info:** not currently used

Within the detailed information, press the enter button (↵) again to activate an **action menu** with the following functions:

- Acknowledge message
- Delete message
- Acknowledge all
- Delete all

10.1.2 Diagnosis

The diagnostics function is activated by selecting the Diagnostics menu item. The ESC button (⏏) deactivates the diagnostics function and clears the contents of the recordings.

The recorded diagnostic data is displayed in 2 fields. In the upper half of the display, status messages of the AMS and the bar graph are displayed. The lower half contains information used for Leuze-internal evaluation.

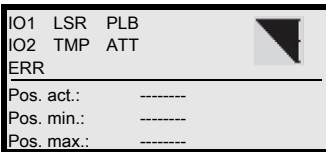

Use the up/down buttons (▲ ▼) to scroll in the bottom half between various displays. The contents of the scrollable pages are intended solely for Leuze for internal evaluation.

The diagnostics have no influence on communication with the host interface and can be activated during operation of the AMS 335*i*.

10.1.3 Expanded diagnosis

The Expanded diagnosis menu item is used for Leuze-internal evaluation.

10.2 General causes of errors

10.2.1 Power LED

See also Chapter 8.2.2.

Error	Possible error cause	Measure
PWR LED "OFF"	No supply voltage connected	Check supply voltage.
	Hardware error	Send in device.
PWR LED "flashes red"	Light beam interruption	Check alignment.
	Plausibility error	Traverse rate >10m/s.
PWR LED "static red"	Hardware error	For error description, see display, It may be necessary to send in the device.

Table 10.1: General causes of errors

10.3 Interface errors

10.3.1 NET LED

For further information on the LED status displays.

Error	Possible error cause	Measure
NET LED "OFF"	Power off on AMS 335/	Check supply voltage.
NET LED "flashes red"	Invalid configuration	
NET LED "static red"	No bus connection	
NET LED "flashes green/red"	<ul style="list-style-type: none"> - Bus error - Time out - RX/TX buffer overflow - Termination error 	

Table 10.2: Bus error

10.4 Status indicators in the display of the AMS 335/

Display	Possible error cause	Measure
PLB (implausible measurement values)	Laser beam interruption	Laser spot must always be incident on the reflector.
	Laser spot outside of reflector	Traverse rate < 10m/s?
	Measurement range for maximum distance exceeded	Restrict traversing path or select AMS with larger measurement range.
	Velocity greater than 10m/s	Reduce velocity.
	Ambient temperature far outside permissible range (TMP display; PLB)	Select AMS with heating or ensure cooling.
ATT (insufficient received signal level)	Reflector soiled	Clean reflector or glass lens.
	Glass lens of the AMS soiled	
	Performance reduction due to snow, rain, fog, condensing vapor or heavily polluted air (oil mist, dust)	Optimize usage conditions.
	Laser spot only partially on reflector	Check alignment.
TMP (operating temperature outside of specification)	Protective film on reflector	Remove protective film from reflector.
	Ambient temperatures outside specified range	In case of low temperatures, remedy may be an AMS with heating. If temperatures are too high, provide cooling or change mounting location.
LSR Laser diode warning	Laser diode prefailure message	Send in device at next possible opportunity to have laser diode replaced. Have replacement device ready.
ERR Hardware error	Indicates an uncorrectable error in the hardware	Send in device for repair.

Service hotline:

You can find the contact information for the hotline in your country on our website www.leuze.com under "Contact & Support".

Repair service and returns:

Defective devices are repaired at our service centers competently and quickly. We offer you an extensive service packet to keep any system downtimes to a minimum. Our service center requires the following information:

- Your customer number
- Product description or part description
- Serial number and batch number
- Reason for requesting support together with a description

For this purpose, please register the merchandise concerned. Simply register return of the merchandise on our website www.leuze.com under Contact & Support -> Repair Service & Returns:

To ensure quick and easy processing of your request, we will send you a returns order with the returns address in digital form.

**Note!**

Please use Chapter 10 as a master copy should servicing be required.

Cross the items in the "Measures" column which you have already examined, fill out the following address field and fax the pages together with your service contract to the fax number listed below.

Customer data (please complete)

Device type:	
Company:	
Contact person/department:	
Phone (direct dial):	
Fax:	
Street / no.:	
ZIP code / City:	
Country:	

Leuze Service fax number:

+49 7021 573 - 199

11 Type overview and accessories

11.1 Part number code

AMS 3xx / yyy H

Heating option	H =	With heating
Operating range	40	Max. operating range in m
	120	Max. operating range in m
	200	Max. operating range in m
	300	Max. operating range in m
	i =	Integrated fieldbus technology
Interface	00	RS 422/RS 232
	01	RS 485
	04	PROFIBUS DP / SSI
	08	TCP/IP
	35	CANopen
	38	EtherCAT
	48	PROFINET RT
	55	DeviceNet
	58	EtherNet/IP
84	Interbus	

AMS Absolute Measurement System

11.1.1 Type overview AMS 335/i(CANopen)

Type designation	Description	Part no.
AMS 335/40	40m operating range, CANopen interface	50113693
AMS 335/120	120m operating range, CANopen interface	50113694
AMS 335/200	200m operating range, CANopen interface	50113695
AMS 335/300	300m operating range, CANopen interface	50113696
AMS 335/40 H	40m operating range, CANopen interface, integrated heating	50113697
AMS 335/120 H	120m operating range, CANopen interface, integrated heating	50113698
AMS 335/200 H	200m operating range, CANopen interface, integrated heating	50113699
AMS 335/300 H	300m operating range, CANopen interface, integrated heating	50113700

Table 11.1: Overview of AMS 335/i types

11.2 Overview of reflector types

Type designation	Description	Part no.
REF 4-A-150x150	Reflective tape, 150x150mm, self-adhesive	50141015
Reflective tape 200x200-S	Reflective tape, 200x200mm, self-adhesive	50104361
REF 4-A-300x300	Reflective tape, 300x300mm, self-adhesive	50141014
Reflective tape 500x500-S	Reflective tape, 500x500mm, self-adhesive	50104362
Reflective tape 914x914-S	Reflective tape, 914x914mm, self-adhesive	50108988
Reflective tape 200x200-M	Reflective tape, 200x200mm, affixed to carrier plate	50104364
Reflective tape 500x500-M	Reflective tape, 500x500mm, affixed to carrier plate	50104365
Reflective tape 914x914-M	Reflective tape, 914x914mm, affixed to carrier plate	50104366
Reflective tape 200x200-H	Reflective tape, 200 x 200mm, heated	50115020
Reflective tape 500x500-H	Reflective tape, 500 x 500mm, heated	50115021
Reflective tape 914x914-H	Reflective tape, 914 x 914mm, heated	50115022

Table 11.2: Overview of reflector types

11.3 Accessories

11.3.1 Accessories – Mounting bracket

Type designation	Description	Part no.
MW OMS/AMS 01	Mounting bracket for mounting AMS 335/ to horizontal surfaces	50107255

Table 11.3: Accessories – Mounting bracket

11.3.2 Accessories – Deflector unit

Type designation	Description	Part no.
US AMS 01	Deflector unit with integrated mounting bracket for AMS 335/ Variable 90° deflection of laser beam in different directions	50104479
US 1 OMS	Deflector unit without mounting bracket for simple 90° deflection of laser beam	50035630

Table 11.4: Accessories – Deflector unit

11.3.3 Accessories – M12 connector

Type designation	Description	Part no.
KD 01-5-BA	M12 connector, A-coded socket, 5-pin, BUS IN	50040097
KD 01-5-SA	M12 connector, A-coded connector, 5-pin, BUS OUT	50040098
KD 095-5A	M12 connector, A-coded socket, 5-pin, Power (PWR)	50020501

Table 11.5: Accessories – M12 connector

11.3.6 Accessory ready-made cables for CANopen

Contact assignment of CANopen connection cable

CANopen connection cable (5-pin socket/connector, A-coded)				
	Pin	Name	Core color	Comment
<p>BUS OUT</p> <p>M12 socket (A-coded)</p> <p>BUS IN</p> <p>M12 connector (A-coded)</p>	1	Drain	-	Shield
	2	NC	-	Not assigned
	3	NC	-	Not assigned
	4	CAN_H	White	Data signal CAN_H
	5	CAN_L	Blue	Data signal CAN_L
	Thread	FE	-	Functional earth (housing)

Technical data of the CANopen connection cable

Operating temperature range

In idle state: -40°C ... +80°C

In motion: -5°C ... +80°C

Material

The cables comply with the CANopen requirements,
Free of halogens, silicone and PVC

Bending radius

> 80mm, suitable for drag chains

Order codes of CANopen connection cable

Type designation	Comment	Part no.
KB DN/CAN-2000-BA	M12 socket for BUS IN, axial connector, open cable end, cable length 2m	50114692
KB DN/CAN-5000-BA	M12 socket for BUS IN, axial connector, open cable end, cable length 5m	50114696
KB DN/CAN-10000-BA	M12 socket for BUS IN, axial connector, open cable end, cable length 10m	50114699
KB DN/CAN-30000-BA	M12 socket for BUS IN, axial connector, open cable end, cable length 30m	50114701
KB DN/CAN-2000-SA	M12 connector for BUS OUT, axial connector, open cable end, cable length 2m	50114693
KB DN/CAN-5000-SA	M12 connector for BUS OUT, axial connector, open cable end, cable length 5m	50114697
KB DN/CAN-10000-SA	M12 connector for BUS OUT, axial connector, open cable end, cable length 10m	50114700
KB DN/CAN-30000-SA	M12 connector for BUS OUT, axial connector, open cable end, cable length 30m	50114702
KB DN/CAN-1000-SBA	M12 connector + M12 socket for CANopen, axial connectors, cable length 1m	50114691
KB DN/CAN-2000-SBA	M12 connector + M12 socket for CANopen, axial connectors, cable length 2m	50114694
KB DN/CAN-5000-SBA	M12 connector + M12 socket for CANopen, axial connectors, cable length 5m	50114698

12 Maintenance

12.1 General maintenance information

With normal use, the laser measurement system does not require any maintenance by the operator.

Cleaning

In the event of dust build-up or if the warning message (ATT) is displayed, clean the device with a soft cloth; use a cleaning agent (commercially available glass cleaner) if necessary. Also check the reflector for possible soiling.



Attention!

Do not use solvents and cleaning agents containing acetone. The use of such solvents can dull the reflector, the housing window and the display.

12.2 Repairs, servicing



Attention!

Access to or changes on the device, except where expressly described in this operating manual, is not authorized. The device must not be opened. Failure to comply will render the guarantee void. Warranted features cannot be guaranteed after the device has been opened.

Repairs to the device must only be carried out by the manufacturer.

 *Contact your Leuze distributor or service organization should repairs be required. The addresses can be found on the inside of the cover and on the back.*



Note!

When sending laser measurement systems to Leuze for repair, please provide an accurate description of the fault.

12.3 Disassembling, packing, disposing

Repacking

For later reuse, the device is to be packed so that it is protected.

Note!

Electrical scrap is a special waste product! Observe the locally applicable regulations regarding disposal of the product.

A

Accessories	95
Accessories – Deflector unit	96
Accessories – M12 connector	96
Accessories – Mounting bracket	96
Accessories – Ready-made cables	97
Accessories – Terminating resistor	97
Accuracy	14
Air humidity	15
Alignment	20

C

CANopen BUS IN connections	38
CANopen interface	53
Cleaning	100
Connections	
CANopen BUS OUT	39
PWR IN	38
Service	39
Contouring error calculation	14
Control buttons	43
Control panel	40
Counting direction	70

D

Declaration of Conformity	5
Deflector unit	
Maximum operating range	24
With integrated mounting bracket	24
Without mounting bracket	26
Deflector unit US 1 OMS	
Dimensioned drawing	26
Deflector unit US AMS 01	
Dimensioned drawing	25
Description of functions	6
Diagnosis	90
Dimensioned drawing of AMS 3xxi	16
Display	40

E

EDS file	13
Electrical connection	37
Safety notices	37
Expanded diagnosis	91
Explanation of symbols	5

F

Fast commissioning	12
--------------------	----

G

General causes of errors	92
--------------------------	----

H

Heated reflectors	
Dimensioned drawing	31
Technical data	30

I

Installation	18
Interface errors	93
Interface info in display	41
Internal hardware error	41

M

Main menu	
Device information	44
Language selection	45
Network information	44
Parameter	45
Service	45
Maintenance	100
Measurement range	14
Menus	
Language selection menu	50
Main menu	44
Parameter menu	45
Service menu	50
Mounting	19
With laser beam deflector unit	24
Mounting bracket (optional)	21

N

Name plates	18
NET LED	42

O

Operating principle	12
Operating range	95
Operating temperature	15
Operation	40, 51
Output time	14
Overview of reflector types	96

P	
Package contents	18
Parallel mounting	22
Parameter enable	51, 52
Parameter menu	
CANopen	46
I/O	47
Other	49
Parameter handling	45
Position value	46
Plausibility error	41
Prefailure message	40
PWR LED	42
Q	
Quality assurance	5
R	
Received signal	41
Reflective tape	
Dimensioned drawing	29
Technical data	28
Reflector	27
Mounting	33
Pitch	36
Size	32
Type overview	32
Repair	100
Response time	14
S	
Servicing	100
Status and measurement data - main menu	45
Status and warning messages	40
Status indicator	40
ATT	93
ERR	93
PLB	93
TMP	93
Status indicator – LSR	93
Status indicators	42
Status indicators in the display	93
Status messages	90
Storage	18
Storage temperature	15
Supply voltage	14
Surface reflections	34
Symbols	5
T	
Technical data	14
Dimensioned drawing	16
General specifications	14
Reflective tapes	27
Temperature monitoring	40
Terminator plug	57
Transport	18
Troubleshooting	90
Type overview	17, 95

Level 1	Level 2	Level 3	Level 4	Level 5	Selection/configuration option	Detailed information on	
▲▼ : Selection	▲▼ : Selection ESC : Back	▲▼ : Selection ESC : Back	▲▼ : Selection ESC : Back	▲▼ : Selection ESC : Back	▲▼ : Selection ↵ : Activate ESC : Back		
Device information						Page 44	
Network information						Page 44	
Status and measurement data						Page 44	
Parameter	↵ Parameter handling	↵ Parameter enable			ON/OFF	Page 45	
		↵ Password	↵ Activate password		ON/OFF		
			↵ Password entry		For setting a four-digit numerical password		
		↵ Parameters to default			All parameters are reset to their factory settings		
↵ CANopen	↵	↵ Activation			ON/OFF	Page 46	
		↵ Node ID					
		↵ Baud rate			20kbit/s / 50kbit/s / 125kbit/s / 250kbit/s / 500kbit/s / 800kbit/s / 1Mbit/s		
		↵ Position resolution			0.01 mm / 0.1 mm / 1 mm / 10 mm / free resolution		
		↵ Velocity resolution			1 mm / 10 mm / 100 mm / 1000 mm / free resolution		
↵ Position value	↵	↵ Unit			Metric/Inch	Page 46	
		↵ Counting direction			Positive/Negative		
		↵ Offset			Value input:		
		↵ Preset			Value input		
		↵ Error delay			ON/OFF		
		↵ Position value in the case of failure			Last valid value / zero		
		↵ Free resolution value			5 ... 50000		
↵ I/O	↵ I/O 1	↵ Port configuration	↵ Switching input	↵ Function	No function/teach preset/laser ON/OFF	Page 47	
			↵ Activation	Low active/High active			
		↵ Switching output	↵ Function	Pos. limit value 1 / Pos. limit value 2 / Velocity / Intensity (ATT) / Temp. (TMP) / Laser (LSR) / Plausibility (PLB) / Hardware (ERR)			
			↵ Activation	Low active/High active			
		↵ I/O 2	↵ Port configuration	↵ Switching input	↵ Function		No function/teach preset/laser ON/OFF
				↵ Activation	Low active/High active		
	↵ Switching output		↵ Function	Pos. limit value 1 / Pos. limit value 2 / Velocity / Intensity (ATT) / Temp. (TMP) / Laser (LSR) / Plausibility (PLB) / Hardware (ERR)			
			↵ Activation	Low active/High active			
	↵ Limit values	↵	↵ Upper pos. limit 1	↵ Activation	ON/OFF		
				↵ Limit value input	Value input in mm or inch/100		
			↵ Lower pos. limit 1	↵ Activation	ON/OFF		
				↵ Limit value input	Value input in mm or inch/100		
	↵ Upper pos. limit 2	↵ Activation	ON/OFF				
↵ Limit value input		Value input in mm or inch/100					
↵ Lower pos. limit 2	↵ Activation	ON/OFF					

			↔ Limit value input	Value input in mm or inch/100		
↔ Other	↔ Heating control			Standard/extended (10 °C ... 15 °C/30 °C ... 35 °C)	Page 49	
	↔ Display background			10 minutes/ON		
	↔ Display contrast			Weak/Medium/Strong		
	↔ Service RS232	↔ Baud rate				57.6kbit/s / 115.2kbit/s
		↔ Format				8,e,1 / 8,n,1
↔ Language selection				Deutsch / English / Español / Français / Italiano	Page 50	
↔ Service	↔ Status messages			Number of readings, reading gates, reading rate / non-reading rate etc.	Page 50	
	↔ Diagnosis			Only for use by Leuze personnel for service purposes		
	↔ Expanded diagnosis			Only for use by Leuze personnel for service purposes		